

绕线贴片功率电感—WPN 系列

Wire Wound SMD Power Inductors – WPN Series

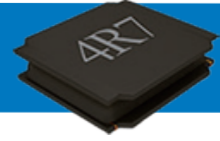

工作温度 Operating Temp

- ◆ -40°C ~ +125°C (Including self-heating)

特征 Features

- ◆ 采用金属铁磁芯，具有更高的饱和电流
- ◆ 在磁芯上金属化电极，抗跌落冲击强，经久耐用
- ◆ 闭合磁路结构设计，漏磁少，抗 EMI 能力强
- ◆ 低直流电阻降低能量损耗，省电省空间
- ◆ 全自动化生产，产品品质高，一致性好
- ◆ Fe base metal material core provides large saturation current
- ◆ Metallization on ferrite core results in excellent shock resistance and damage-free durability
- ◆ Closed magnetic circuit design reduces leakage flux and Electro Magnetic Interference (EMI)
- ◆ Low DCR decreases power loss, small and slim take up less PCB real estate
- ◆ Automatic production ensures high quality and consistency

用途 Applications

- ◆ 智能手机、机顶盒、虚拟现实、增强现实
- ◆ 笔记本电脑、台式电脑、服务器
- ◆ 便携式游戏机、个人导航系统、多媒体
- ◆ Smart phone, set top box, VR, AR
- ◆ Notebooks, desktop computers, servers
- ◆ Portable gaming devices, personal navigation systems, personal multimedia devices

产品型号 Product Identification

1	2	3	4	5	6	7
WPN	252012	H	2R2	M	T	□□□

1 分类 Type	
WPN	绕线贴片功率电感 Wire Wound SMD Power Inductor

2 外形尺寸 (L×W×H) [mm] External Dimensions (L×W×H) [mm]	
201610	2.0×1.6×1.0
201612	2.0×1.6×1.2
252010	2.5×2.0×1.0
252012	2.5×2.0×1.2
3010	3.0×3.0×1.0
3012	3.0×3.0×1.2
4010	4.0×4.0×1.0
4012	4.0×4.0×1.2
4020	4.0×4.0×2.0

3 特性类别 Feature Type	
H	H Type
M	M Type
U	U Type
E	E Type
F	F Type
P	P Type
S	S Type
HS	HS Type

4 公称感量 Nominal Inductance	
Example	Nominal Value
R47	0.47μH
2R2	2.2μH

5 感量精度 Inductance Tolerance	
N	±30%
M	±20%

6 包装 Packing	
T	编带 Tape & Reel

7 设计代号 Design Code	
□□□	Design Code
*Standard product is blank	

外观尺寸 Shape and Dimensions

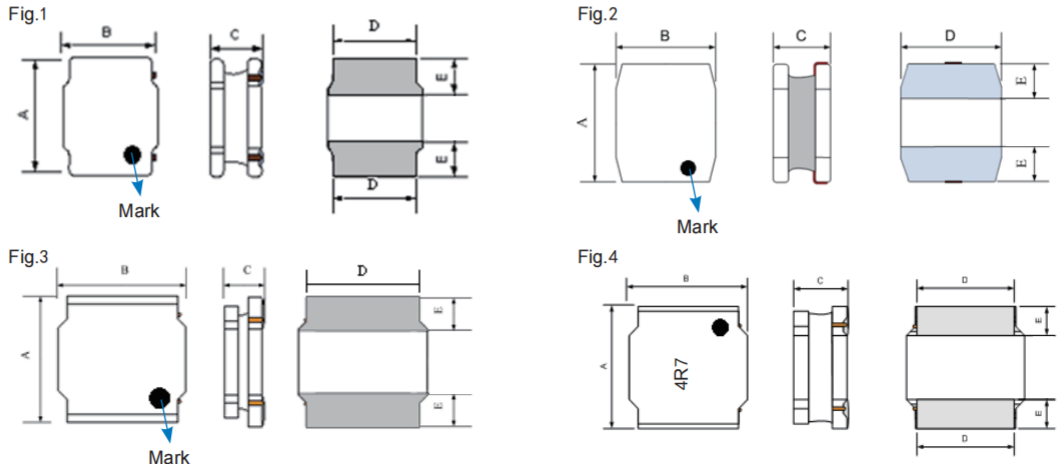

外观尺寸

Shape and Dimensions

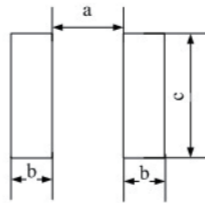

Recommended Land Pattern

Unit: mm

Series	Shape	A	B	C Max.	D	E	a Typ.	b Typ.	c Typ.
WPN201610H/HS	Fig.1	2.0±0.2	1.6±0.2	1.0	1.5±0.2	0.6±0.2	0.7	0.7	1.7
WPN201610M	Fig.1	2.0±0.2	1.6±0.2	1.0	1.2±0.2	0.6±0.2	0.7	0.7	1.7
WPN201610U	Fig.2	2.0±0.2	1.6±0.2	1.0	1.6±0.2	0.6±0.2	0.7	0.7	1.7
WPN201610P	Fig.1	2.0±0.2	1.6±0.2	1.0/1.05	1.5±0.2	0.6±0.2	0.7	0.7	1.6
WPN201610S	Fig.1	2.0±0.2	1.6±0.2	1.0	1.5±0.2	0.6±0.2	0.7	0.7	1.6
WPN201612H	Fig.1	2.0±0.2	1.6±0.2	1.2.	1.2±0.2	0.6±0.2	0.7	0.7	1.7
WPN252010H/HS	Fig.1	2.5±0.2	2.0±0.2	1.0	1.65±0.2	0.8±0.2	0.8	0.85	2.0
WPN252010U	Fig.2	2.5±0.2	2.0±0.2	1.0	2.0±0.2	0.6±0.2	1.2	0.8	2.0
WPN252010F	Fig.1	2.5±0.2	2.0±0.2	1.0	1.75±0.2	0.8±0.2	0.8	0.85	2.0
WPN252010P	Fig.1	2.5±0.2	2.0±0.2	1.0	1.75±0.2	0.8±0.2	0.8	0.85	2.0
WPN252010S	Fig.1	2.5±0.2	2.0±0.2	1.0	1.75±0.2	0.8±0.2	0.8	0.85	2.0
WPN252012H/HS	Fig.1	2.5±0.2	2.0±0.2	1.2	1.65±0.2	0.8±0.2	0.8	0.85	2.0
WPN252012E	Fig.1	2.5±0.2	2.0±0.2	1.2	1.65±0.2	0.8±0.2	0.8	0.85	2.0
WPN252012S	Fig.1	2.5±0.2	2.0±0.2	1.2	1.75±0.2	0.8±0.2	0.8	0.85	2.0
WPN3010HS	Fig.3	3.0±0.2	3.0±0.2	1.0	2.6±0.2	0.75±0.2	1.5	0.8	3.2
WPN3012H/HS	Fig.3	3.0±0.2	3.0±0.2	1.2	2.6±0.2	0.75±0.2	1.5	0.8	3.2
WPN4010HS	Fig.4	4.0±0.2	4.0±0.2	1.0	3.1±0.2	0.95±0.2	1.9	1.1	3.7
WPN4012H/HS	Fig.4	4.0±0.2	4.0±0.2	1.2	3.4±0.2	0.95±0.2	1.9	1.1	3.7
WPN4020H	Fig.4	4.0±0.2	4.0±0.2	2.0	3.4±0.2	0.95±0.2	1.9	1.1	3.7

规格特性

Specifications

WPN201610H Series

型号 Part Number	电感量 Inductance	直流电阻 DC Resistance		自谐振频率 Self-resonant Frequency	饱和电流 Saturation Current		温升电流 Heat Rating Current	
	@1MHz,1V	Max.	Typ.	Min.	Max.	Typ.	Max.	Typ.
单位 Units	μH	Ω		MHz	A		A	
符号 Symbol	L	DCR		S.R.F	Isat		Irms	
WPN201610HR24MT	0.24±20%	0.040	0.033	145	4.50	5.50	3.00	3.45
WPN201610HR47MT	0.47±20%	0.049	0.041	102	4.00	4.70	2.70	3.10
WPN201610HR68MT	0.68±20%	0.065	0.057	77	3.50	4.00	2.50	2.80
WPN201610H1R0MT	1.0±20%	0.090	0.075	70	3.35	3.85	2.05	2.35
WPN201610H1R0MTY01	1.0±20%	0.070	0.060	65	2.60	3.05	2.20	2.55
WPN201610H1R5MT	1.5±20%	0.130	0.110	45	1.95	2.30	1.70	2.00
WPN201610H2R2MT	2.2±20%	0.170	0.142	39	1.90	2.15	1.45	1.70
WPN201610H4R7MT	4.7±20%	0.425	0.370	25	1.20	1.50	0.90	1.00
WPN201610H100MT	10±20%	0.826	0.688	15	0.80	0.95	0.65	0.75

WPN201610HS Series

型号 Part Number	电感量 Inductance	直流电阻 DC Resistance		自谐振频率 Self-resonant Frequency	饱和电流 Saturation Current		温升电流 Heat Rating Current	
	@1MHz,1V	Max.	Typ.	Min.	Max.	Typ.	Max.	Typ.
单位 Units	μH	Ω		MHz	A		A	
符号 Symbol	L	DCR		S.R.F	Isat		Irms	
WPN201610HS4R7MT	4.7±20%	0.425	0.370	25	1.50	1.70	0.90	1.00
WPN201610HS100MT	10±20%	0.826	0.688	15	0.95	1.10	0.65	0.75

规格特性
Specifications

WPN201610M Series

型号 Part Number	电感量 Inductance	直流电阻 DC Resistance		自谐频率 Self-resonant Frequency	饱和电流 Saturation Current		温升电流 Heat Rating Current	
	@1MHz,1V	Max.	Typ.	Min.	Max.	Typ.	Max.	Typ.
单位 Units	μH	Ω		MHz	A		A	
符号 Symbol	L	DCR		S.R.F	Isat		Irms	
WPN201610MR24MT	0.24±20%	0.026	0.022	160	5.90	6.80	4.35	4.80
WPN201610MR33MT	0.33±20%	0.038	0.032	120	5.50	6.00	3.40	3.80
WPN201610MR47MT	0.47±20%	0.044	0.037	107	4.30	5.20	3.00	3.30
WPN201610MR68MT	0.68±20%	0.060	0.050	92	3.60	4.20	2.60	3.00
WPN201610M1R0MT	1.0±20%	0.090	0.075	52	3.35	3.85	2.05	2.35
WPN201610M2R2MT	2.2±20%	0.160	0.135	41	1.80	2.00	1.60	1.75

WPN201610U Series

型号 Part Number	电感量 Inductance	直流电阻 DC Resistance		自谐频率 Self-resonant Frequency	饱和电流 Saturation Current		温升电流 Heat Rating Current	
	@1MHz,1V	Max.	Typ.	Min.	Max.	Typ.	Max.	Typ.
单位 Units	μH	Ω		MHz	A		A	
符号 Symbol	L	DCR		S.R.F	Isat		Irms	
WPN201610UR12MT	0.12±20%	0.015	0.012	250	9.50	11.00	5.60	6.50
WPN201610UR22MT	0.22±20%	0.022	0.017	159	6.00	6.70	4.50	5.20
WPN201610UR24MT	0.24±20%	0.022	0.017	143	5.60	6.70	4.50	5.20
WPN201610UR33MT	0.33±20%	0.025	0.022	121	5.50	6.00	4.10	4.70
WPN201610UR47MT	0.47±20%	0.033	0.028	110	4.50	5.00	3.60	4.10
WPN201610UR68MT	0.68±20%	0.045	0.037	78	3.20	3.70	3.10	3.60
WPN201610U1R0MT	1.0±20%	0.060	0.050	63	3.00	3.50	2.60	3.00
WPN201610U1R5MT	1.5±20%	0.110	0.095	50	2.80	3.20	2.00	2.30
WPN201610U2R2MT	2.2±20%	0.120	0.100	44	1.80	2.10	1.90	2.20
WPN201610U4R7MT	4.7±20%	0.288	0.240	21	1.30	1.50	1.25	1.45

WPN201610P Series

型号 Part Number	电感量 Inductance	直流电阻 DC Resistance		自谐频率 Self-resonant Frequency	饱和电流 Saturation Current		温升电流 Heat Rating Current	
	@1MHz,1V	Max.	Typ.	Min.	Max.	Typ.	Max.	Typ.
单位 Units	μH	Ω		MHz	A		A	
符号 Symbol	L	DCR		S.R.F	Isat		Irms	
WPN201610PR33MT	0.33±20%	0.029	0.024	98	4.50	5.00	3.69	4.10
WPN201610PR47MT	0.47±20%	0.040	0.033	89	4.00	4.40	3.15	3.50
WPN201610P1R0MT	1.0±20%	0.069	0.060	56	2.61	2.91	2.26	2.60
WPN201610P2R2MT	2.2±20%	0.150	0.135	36	1.71	1.90	1.50	1.70

WPN201610S Series

型号 Part Number	电感量 Inductance	直流电阻 DC Resistance		自谐频率 Self-resonant Frequency	饱和电流 Saturation Current		温升电流 Heat Rating Current	
	@1MHz,1V	Max.	Typ.	Min.	Max.	Typ.	Max.	Typ.
单位 Units	μH	Ω		MHz	A		A	
符号 Symbol	L	DCR		S.R.F	Isat		Irms	
WPN201610SR24MTY01	0.24±20%	0.026	0.020	157	6.20	7.00	5.15	5.75
WPN201610SR33MT	0.33±20%	0.030	0.021	104	6.10	6.70	3.60	4.40
WPN201610SR47MT	0.47±20%	0.042	0.023	92	5.30	6.10	3.75	4.00
WPN201610SR68MT	0.68±20%	0.060	0.045	76	3.60	4.20	3.05	3.50
WPN201610S1R0MT	1.0±20%	0.070	0.048	54	3.30	3.90	3.00	3.20
WPN201610S1R5MT	1.5±20%	0.114	0.095	42	2.50	2.70	2.30	2.60
WPN201610S2R2MT	2.2±20%	0.155	0.117	38	2.45	2.60	1.90	2.10

规格特性
Specifications

WPN201612H Series

型号 Part Number	电感量 Inductance	直流电阻 DC Resistance		自谐振频率 Self-resonant Frequency	饱和电流 Saturation Current		温升电流 Heat Rating Current	
	@1MHz,1V	Max.	Typ.	Min.	Max.	Typ.	Max.	Typ.
单位 Units	μH	Ω		MHz	A		A	
符号 Symbol	L	DCR		S.R.F	Isat		Irms	
WPN201612HR24MT	0.24±20%	0.023	0.019	116	5.85	6.75	4.50	5.20
WPN201612HR33MT	0.33±20%	0.031	0.026	95	5.15	6.00	3.85	4.45
WPN201612HR47MT	0.47±20%	0.041	0.034	84	3.95	4.60	3.40	3.90
WPN201612H1R0MT	1.0±20%	0.059	0.049	60	2.70	3.10	2.70	3.00
WPN201612H1R5MT	1.5±20%	0.109	0.091	42	1.90	2.35	2.10	2.45
WPN201612H2R2MT	2.2±20%	0.146	0.122	32	1.70	2.00	1.80	2.05

WPN252010H Series

型号 Part Number	电感量 Inductance	直流电阻 DC Resistance		自谐振频率 Self-resonant Frequency	饱和电流 Saturation Current		温升电流 Heat Rating Current	
	@1MHz,1V	Max.	Typ.	Min.	Max.	Typ.	Max.	Typ.
单位 Units	μH	Ω		MHz	A		A	
符号 Symbol	L	DCR		S.R.F	Isat		Irms	
WPN252010HR33MT	0.33±20%	0.039	0.033	117	4.80	5.50	3.50	4.05
WPN252010HR47MT	0.47±20%	0.045	0.038	80	4.40	5.20	3.20	3.70
WPN252010HR68MT	0.68±20%	0.059	0.049	65	3.20	3.60	2.75	3.20
WPN252010H1R0MT	1.0±20%	0.076	0.063	46	3.10	3.50	2.50	2.90
WPN252010H1R5MT	1.5±20%	0.106	0.088	40	2.60	3.00	2.00	2.30
WPN252010H2R2MT	2.2±20%	0.155	0.129	26	1.90	2.20	1.50	1.80
WPN252010H3R3MT	3.3±20%	0.235	0.196	24	1.60	1.80	1.20	1.40
WPN252010H4R7MT	4.7±20%	0.276	0.230	19	1.30	1.50	1.10	1.30
WPN252010H100MT	10±20%	0.500	0.435	12	0.90	1.00	0.80	0.90

WPN252010HS Series

型号 Part Number	电感量 Inductance	直流电阻 DC Resistance		自谐振频率 Self-resonant Frequency	饱和电流 Saturation Current		温升电流 Heat Rating Current	
	@1MHz,1V	Max.	Typ.	Min.	Max.	Typ.	Max.	Typ.
单位 Units	μH	Ω		MHz	A		A	
符号 Symbol	L	DCR		S.R.F	Isat		Irms	
WPN252010HS4R7MT	4.7±20%	0.276	0.230	19	1.30	1.50	1.10	1.30
WPN252010HS4R7MTY01	4.7±20%	0.290	0.250	19	1.55	1.80	1.05	1.20
WPN252010HS100MT	10±20%	0.500	0.435	12	1.10	1.30	0.80	0.90

WPN252010U Series

型号 Part Number	电感量 Inductance	直流电阻 DC Resistance		自谐振频率 Self-resonant Frequency	饱和电流 Saturation Current		温升电流 Heat Rating Current	
	@1MHz,1V	Max.	Typ.	Min.	Max.	Typ.	Max.	Typ.
单位 Units	μH	Ω		MHz	A		A	
符号 Symbol	L	DCR		S.R.F	Isat		Irms	
WPN252010UR16MT	0.16±20%	0.020	0.016	214	10.0	12.0	5.00	5.80
WPN252010UR24MT	0.24±20%	0.025	0.021	149	8.50	10.0	4.40	5.10
WPN252010UR33MT	0.33±20%	0.025	0.021	117	6.00	6.70	4.40	5.10
WPN252010UR47MT	0.47±20%	0.030	0.025	92	5.30	5.80	4.00	4.60
WPN252010UR68MT	0.68±20%	0.043	0.036	67	5.20	5.70	3.30	3.80
WPN252010U1R0MT	1.0±20%	0.050	0.042	54	4.10	4.60	3.10	3.60
WPN252010U1R5MT	1.5±20%	0.076	0.063	41	3.00	3.40	2.40	2.80
WPN252010U2R2MT	2.2±20%	0.096	0.080	34	2.60	2.90	2.05	2.40
WPN252010U4R7MT	4.7±20%	0.240	0.200	22	1.90	2.20	1.40	1.60

规格特性
Specifications

WPN252010F Series

型号 Part Number	电感量 Inductance	直流电阻 DC Resistance		自谐频率 Self-resonant Frequency	饱和电流 Saturation Current		温升电流 Heat Rating Current	
	@1MHz,1V	Max.	Typ.	Min.	Max.	Typ.	Max.	Typ.
单位 Units	μH	Ω		MHz	A		A	
符号 Symbol	L	DCR		S.R.F	Isat		Irms	
WPN252010FR24MT	0.24±20%	0.025	0.021	/	10.4	11.6	4.40	5.10
WPN252010FR33MT	0.33±20%	0.025	0.021	/	6.00	6.70	4.40	5.10
WPN252010FR47MT	0.47±20%	0.030	0.025	/	5.30	6.00	4.00	4.60
WPN252010FR68MT	0.68±20%	0.043	0.036	/	5.20	5.70	3.30	3.80
WPN252010F1R0MT	1.0±20%	0.060	0.050	/	4.20	4.80	2.85	3.30
WPN252010F2R2MT	2.2±20%	0.156	0.130	/	3.10	3.50	1.60	1.90

WPN252010P Series

型号 Part Number	电感量 Inductance	直流电阻 DC Resistance		自谐频率 Self-resonant Frequency	饱和电流 Saturation Current		温升电流 Heat Rating Current	
	@1MHz,1V	Max.	Typ.	Min.	Max.	Typ.	Max.	Typ.
单位 Units	μH	Ω		MHz	A		A	
符号 Symbol	L	DCR		S.R.F	Isat		Irms	
WPN252010PR33MT	0.33±20%	0.026	0.021	97	6.00	6.60	4.00	4.40
WPN252010PR47MT	0.47±20%	0.032	0.027	79	4.50	5.00	3.51	3.90
WPN252010P1R0MT	1.0±20%	0.065	0.045	54	3.15	3.50	2.70	3.00
WPN252010P2R2MT	2.2±20%	0.125	0.099	31	2.16	2.40	2.07	2.30

WPN252010S Series

型号 Part Number	电感量 Inductance	直流电阻 DC Resistance		自谐频率 Self-resonant Frequency	饱和电流 Saturation Current		温升电流 Heat Rating Current	
	@1MHz,1V	Max.	Typ.	Min.	Max.	Typ.	Max.	Typ.
单位 Units	μH	Ω		MHz	A		A	
符号 Symbol	L	DCR		S.R.F	Isat		Irms	
WPN252010SR33MT	0.33±20%	0.026	0.017	97	7.00	7.80	4.70	5.20
WPN252010SR47MT	0.47±20%	0.032	0.023	79	6.00	6.60	4.20	4.80
WPN252010SR68MT	0.68±20%	0.050	0.040	62	5.00	5.60	3.80	4.40
WPN252010S1R0MT	1.0±20%	0.065	0.041	54	4.00	4.40	3.00	3.20
WPN252010S1R5MT	1.5±20%	0.105	0.085	45	2.60	3.00	2.70	3.05
WPN252010S2R2MT	2.2±20%	0.130	0.088	31	3.00	3.30	2.05	2.30

WPN252012H Series

型号 Part Number	电感量 Inductance	直流电阻 DC Resistance		自谐频率 Self-resonant Frequency	饱和电流 Saturation Current		温升电流 Heat Rating Current	
	@1MHz,1V	Max.	Typ.	Min.	Max.	Typ.	Max.	Typ.
单位 Units	μH	Ω		MHz	A		A	
符号 Symbol	L	DCR		S.R.F	Isat		Irms	
WPN252012HR24MT	0.24±20%	0.023	0.019	117	6.50	7.80	4.05	4.70
WPN252012HR33MT	0.33±20%	0.028	0.023	104	5.30	6.20	3.70	4.30
WPN252012HR47MT	0.47±20%	0.035	0.029	89	4.90	5.60	3.45	4.00
WPN252012HR68MT	0.68±20%	0.043	0.036	67	3.70	4.30	3.15	3.60
WPN252012H1R0MT	1.0±20%	0.054	0.048	52	3.60	4.20	3.00	3.40
WPN252012H1R5MT	1.5±20%	0.072	0.060	38	2.90	3.50	2.40	2.80
WPN252012H2R2MT	2.2±20%	0.120	0.100	32	2.60	3.00	1.90	2.15
WPN252012H2R2MTY01	2.2±20%	0.102	0.085	36	2.90	3.30	2.10	2.40
WPN252012H3R3MT	3.3±20%	0.163	0.136	25	1.70	2.10	1.80	2.05
WPN252012H4R7MT	4.7±20%	0.260	0.225	23	1.60	1.90	1.25	1.45
WPN252012H6R8MT	6.8±20%	0.366	0.305	16	1.15	1.35	0.95	1.10
WPN252012H100MT	10±20%	0.480	0.435	14	1.10	1.35	0.85	1.00

规格特性
Specifications

WPN252012HS Series

型号 Part Number	电感量 Inductance	直流电阻 DC Resistance		自谐频率 Self-resonant Frequency	饱和电流 Saturation Current		温升电流 Heat Rating Current	
	@1MHz,1V	Max.	Typ.	Min.	Max.	Typ.	Max.	Typ.
单位 Units	μH	Ω		MHz	A		A	
符号 Symbol	L	DCR		S.R.F	Isat		Irms	
WPN252012HS4R7MT	4.7±20%	0.260	0.225	23	1.70	1.90	1.25	1.45
WPN252012HS100MT	10±20%	0.480	0.435	14	1.10	1.35	0.85	1.00

WPN252012E Series

型号 Part Number	电感量 Inductance	直流电阻 DC Resistance		自谐频率 Self-resonant Frequency	饱和电流 Saturation Current		温升电流 Heat Rating Current	
	@1MHz,1V	Max.	Typ.	Min.	Max.	Typ.	Max.	Typ.
单位 Units	μH	Ω		MHz	A		A	
符号 Symbol	L	DCR		S.R.F	Isat		Irms	
WPN252012ER33MT	0.33±20%	0.026	0.020	107	8.00	9.00	4.50	5.10
WPN252012ER47MT	0.47±20%	0.032	0.026	92	7.00	8.00	4.10	4.70
WPN252012E1R0MT	1.0±20%	0.044	0.037	52	4.50	5.00	3.50	3.90

WPN252012S Series

型号 Part Number	电感量 Inductance	直流电阻 DC Resistance		自谐频率 Self-resonant Frequency	饱和电流 Saturation Current		温升电流 Heat Rating Current	
	@1MHz,1V	Max.	Typ.	Min.	Max.	Typ.	Max.	Typ.
单位 Units	μH	Ω		MHz	A		A	
符号 Symbol	L	DCR		S.R.F	Isat		Irms	
WPN252012SR47MT	0.47±20%	0.034	0.028	82	6.20	6.80	4.20	4.80
WPN252012SR68MT	0.68±20%	0.043	0.036	69	4.60	5.10	3.65	4.15
WPN252012S1R0MT	1.00±20%	0.054	0.045	61	4.30	4.80	3.30	3.75
WPN252012S1R5MT	1.50±20%	0.072	0.060	42	2.90	3.50	2.70	3.10
WPN252012S2R2MT	2.20±20%	0.100	0.080	32	2.90	3.30	2.35	2.70

WPN3010HS Series

型号 Part Number	电感量 Inductance	直流电阻 DC Resistance		自谐频率 Self-resonant Frequency	饱和电流 Saturation Current		温升电流 Heat Rating Current	
	@1MHz,1V	Max.	Typ.	Min.	Max.	Typ.	Max.	Typ.
单位 Units	μH	Ω		MHz	A		A	
符号 Symbol	L	DCR		S.R.F	Isat		Irms	
WPN3010HS100MT	10±20%	0.432	0.360	16	1.00	1.20	1.20	1.40

WPN3012H Series

型号 Part Number	电感量 Inductance	直流电阻 DC Resistance		自谐频率 Self-resonant Frequency	饱和电流 Saturation Current		温升电流 Heat Rating Current	
	@1MHz,1V	Max.	Typ.	Min.	Max.	Typ.	Max.	Typ.
单位 Units	μH	Ω		MHz	A		A	
符号 Symbol	L	DCR		S.R.F	Isat		Irms	
WPN3012HR33MT	0.33±20%	0.027	0.023	107	7.20	8.90	4.20	4.85
WPN3012HR47MT	0.47±20%	0.033	0.028	86	6.80	8.00	3.90	4.50
WPN3012HR68MT	0.68±20%	0.042	0.035	63	5.80	6.80	3.40	3.90
WPN3012H1R0MT	1.0±20%	0.054	0.045	51	4.20	5.40	2.70	3.10
WPN3012H1R5MT	1.5±20%	0.074	0.064	37	3.40	4.10	2.50	2.90
WPN3012H2R2MT	2.2±20%	0.108	0.090	28	2.80	3.35	2.05	2.35
WPN3012H3R3MT	3.3±20%	0.155	0.129	25	2.20	2.60	1.70	2.00
WPN3012H4R7MT	4.7±20%	0.235	0.196	20	2.00	2.50	1.30	1.50
WPN3012H6R8MT	6.8±20%	0.340	0.290	16	1.60	1.90	1.10	1.25
WPN3012H100MT	10±20%	0.474	0.395	12	1.20	1.45	1.00	1.15

规格特性
Specifications

WPN3012HS Series

型号 Part Number	电感量 Inductance	直流电阻 DC Resistance		自谐振频率 Self-resonant Frequency	饱和电流 Saturation Current		温升电流 Heat Rating Current	
	@1MHz,1V	Max.	Typ.	Min.	Max.	Typ.	Max.	Typ.
单位 Units	μH	Ω		MHz	A		A	
符号 Symbol	L	DCR		S.R.F	Isat		Irms	
WPN3012HS4R7MT	4.7±20%	0.235	0.196	21	2.00	2.50	1.30	1.50
WPN3012HS100MT	10±20%	0.474	0.395	12	1.35	1.65	1.00	1.15
WPN3012HS100MTY01	10±20%	0.415	0.360	17	1.90	2.15	1.35	1.55
WPN3012HS150MT	15±20%	0.635	0.550	13	1.55	1.75	1.10	1.25

WPN4010HS Series

型号 Part Number	电感量 Inductance	直流电阻 DC Resistance		自谐振频率 Self-resonant Frequency	饱和电流 Saturation Current		温升电流 Heat Rating Current	
	@1MHz,1V	Max.	Typ.	Min.	Max.	Typ.	Max.	Typ.
单位 Units	μH	Ω		MHz	A		A	
符号 Symbol	L	DCR		S.R.F	Isat		Irms	
WPN4010HS4R7MT	4.7±20%	0.197	0.164	28	1.95	2.30	1.85	2.10
WPN4010HS6R8MT	6.8±20%	0.260	0.217	20	1.50	1.75	1.55	1.75
WPN4010HS100MT	10±20%	0.335	0.280	10	1.40	1.65	1.40	1.60

WPN4012H Series

型号 Part Number	电感量 Inductance	直流电阻 DC Resistance		自谐振频率 Self-resonant Frequency	饱和电流 Saturation Current		温升电流 Heat Rating Current	
	@1MHz,1V	Max.	Typ.	Min.	Max.	Typ.	Max.	Typ.
单位 Units	μH	Ω		MHz	A		A	
符号 Symbol	L	DCR		S.R.F	Isat		Irms	
WPN4012HR33MT	0.33±20%	0.032	0.027	113	10.30	11.50	4.30	4.90
WPN4012HR47MT	0.47±20%	0.041	0.034	96	9.10	9.90	3.80	4.40
WPN4012HR68MT	0.68±20%	0.041	0.034	70	5.50	6.35	3.80	4.40
WPN4012H1R0MT	1.0±20%	0.059	0.049	55	5.70	6.60	3.20	3.70
WPN4012H1R0MTY01	1.0±20%	0.049	0.041	56	4.50	5.30	3.60	4.20
WPN4012H1R2MT	1.2±20%	0.059	0.049	48	4.00	4.80	3.20	3.70
WPN4012H1R5MT	1.5±20%	0.070	0.058	38	3.90	4.60	2.90	3.30
WPN4012H2R2MT	2.2±20%	0.079	0.066	28	2.80	3.30	2.70	3.10
WPN4012H3R3MT	3.3±20%	0.125	0.104	23	2.80	3.30	2.10	2.50
WPN4012H4R7MT	4.7±20%	0.166	0.138	19	2.30	2.60	1.90	2.20
WPN4012H6R8MT	6.8±20%	0.226	0.188	17	1.60	2.20	1.60	1.85
WPN4012H100MT	10±20%	0.335	0.279	12	1.55	1.85	1.30	1.50
WPN4012H220MT	22±20%	0.679	0.566	7	1.05	1.30	0.90	1.05

WPN4012HS Series

型号 Part Number	电感量 Inductance	直流电阻 DC Resistance		自谐振频率 Self-resonant Frequency	饱和电流 Saturation Current		温升电流 Heat Rating Current	
	@1MHz,1V	Max.	Typ.	Min.	Max.	Typ.	Max.	Typ.
单位 Units	μH	Ω		MHz	A		A	
符号 Symbol	L	DCR		S.R.F	Isat		Irms	
WPN4012HS4R7MT	4.7±20%	0.162	0.135	28	2.60	3.00	2.05	2.35
WPN4012HS100MT	10±20%	0.276	0.230	12	1.80	2.10	1.55	1.75

WPN4020H Series

型号 Part Number	电感量 Inductance	直流电阻 DC Resistance		自谐振频率 Self-resonant Frequency	饱和电流 Saturation Current		温升电流 Heat Rating Current	
	@1MHz,1V	Max.	Typ.	Min.	Max.	Typ.	Max.	Typ.
单位 Units	μH	Ω		MHz	A		A	
符号 Symbol	L	DCR		S.R.F	Isat		Irms	
WPN4020HR22MT	0.22±20%	0.013	0.011	108	18.70	22.00	8.20	9.50
WPN4020HR47MT	0.47±20%	0.022	0.018	72	13.40	15.50	6.40	7.40
WPN4020HR68MT	0.68±20%	0.022	0.018	57	8.70	11.10	6.40	7.40
WPN4020H1R0MT	1.0±20%	0.026	0.022	37	8.70	11.10	5.80	6.70

规格特性 Specifications

WPN4020H Series

型号 Part Number	电感量 Inductance	直流电阻 DC Resistance		自谐振频率 Self-resonant Frequency	饱和电流 Saturation Current		温升电流 Heat Rating Current	
	@1MHz, 1V	Max.	Typ.	Min.	Max.	Typ.	Max.	Typ.
单位 Units	μH	Ω		MHz	A		A	
符号 Symbol	L	DCR		S.R.F	Isat		Irms	
WPN4020H1R5MT	1.5 \pm 20%	0.036	0.030	30	7.70	9.60	5.20	6.00
WPN4020H2R2MT	2.2 \pm 20%	0.048	0.040	25	6.10	7.60	4.30	5.00
WPN4020H3R3MT	3.3 \pm 20%	0.072	0.060	19	4.70	5.90	3.45	4.00
WPN4020H4R7MT	4.7 \pm 20%	0.108	0.090	17	4.00	4.90	2.85	3.30
WPN4020H6R8MT	6.8 \pm 20%	0.156	0.130	13	3.00	4.20	2.40	2.80
WPN4020H100MT	10 \pm 20%	0.216	0.180	11	2.80	3.50	2.00	2.35

※1: 所有的测试数据均在 20°C 环境温度下进行;
※1: All test data is referenced to 20°C ambient;

※2: 额定电流: 以饱和电流和温升电流中较小者为标准;
※2: Rated current: Isat or Irms, whichever is smaller;

※3: WPN2016 & WPN2520 尺寸最大 DC 耐压 25V; WPN30 & WPN40 尺寸最大 DC 耐压 40V;
※3: For WPN2016 & WPN2520 size inductors, absolute maximum voltage DC 25V; For WPN30&WPN40 size inductors, absolute maximum voltage DC 40V;

※ 饱和电流: 使电感值从初始状态下下降约 30% 的直流电流值;
※ Isat: DC current at which the inductance drops approximate 30% from its value without current;

※ 温升电流: 使产品表面温度从 20°C 升高 ($\Delta T=40^\circ\text{C}$) 的直流电流值。
※ Irms: DC current that causes the temperature rise ($\Delta T=40^\circ\text{C}$) from 20°C ambient.

※ WPN-HS 系列磁体采用铁合金材质, 表面采用了 Coating 技术, 通过自动化包衣设备, 将耐高温、高绝缘树脂均匀包覆在铁粉磁芯表面, 进一步提高产品的耐压、耐腐蚀能力。
※ WPN-HS series is processed with surface coating technology, coated by the resin of high voltage insulation level coating on the core surface evenly by automatic equipment, to improve the voltage insulation and corrosion resistance of the core.

电气特性 Typical Electrical Characteristics

WPN201610H Series

Temperature vs. DC Current Characteristics

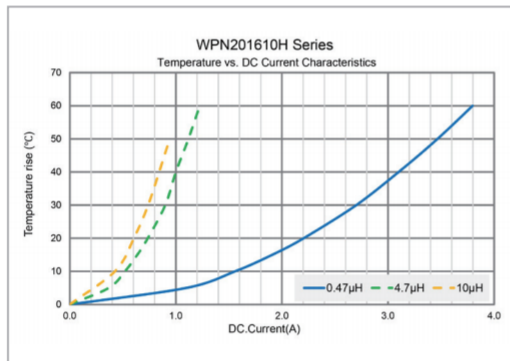

Inductance vs. DC Current Characteristics

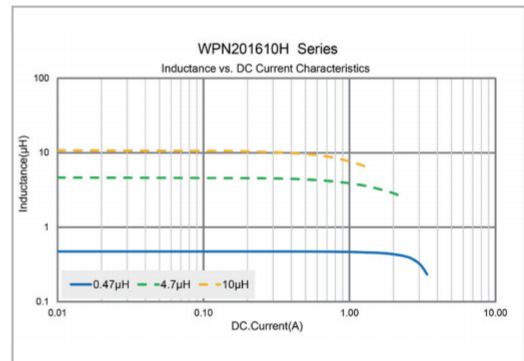

WPN201610HS Series

Temperature vs. DC Current Characteristics

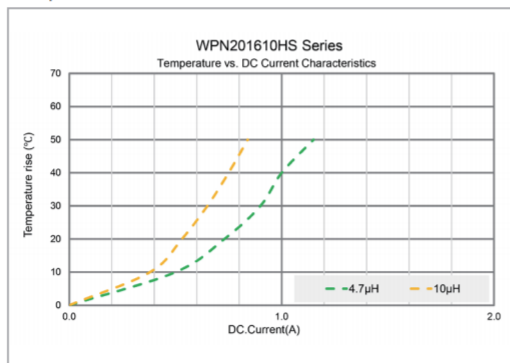

Inductance vs. DC Current Characteristics

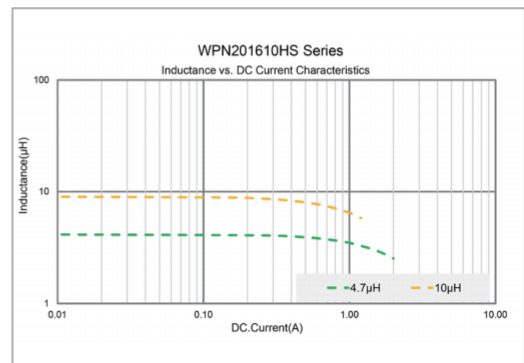

电气特性
Typical
Electrical
Characteristics

WPN201610M Series

Temperature vs. DC Current Characteristics

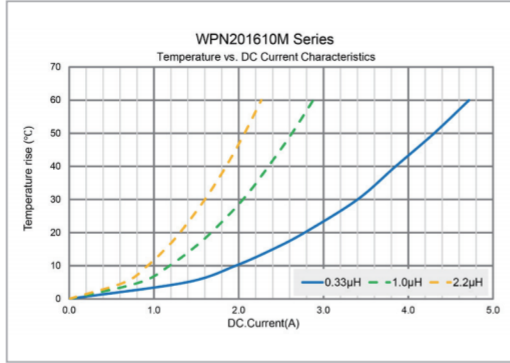

Inductance vs. DC Current Characteristics

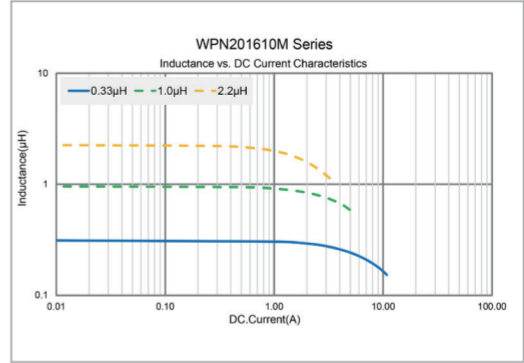

WPN201610U Series

Temperature vs. DC Current Characteristics

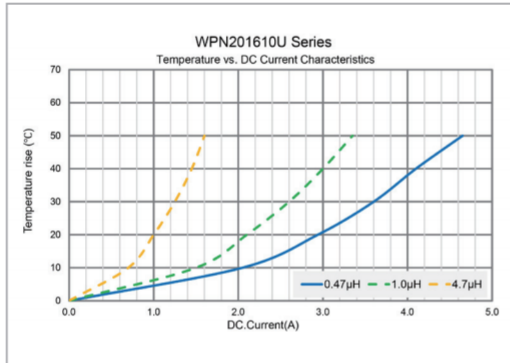

Inductance vs. DC Current Characteristics

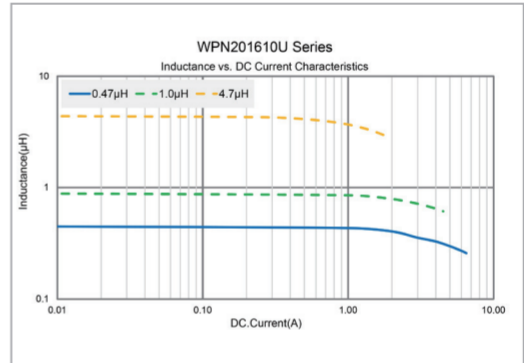

WPN201610P Series

Temperature vs. DC Current Characteristics

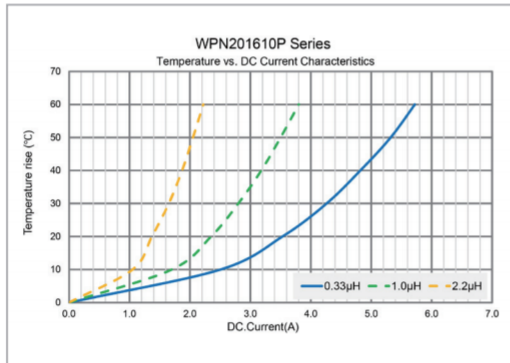

Inductance vs. DC Current Characteristics

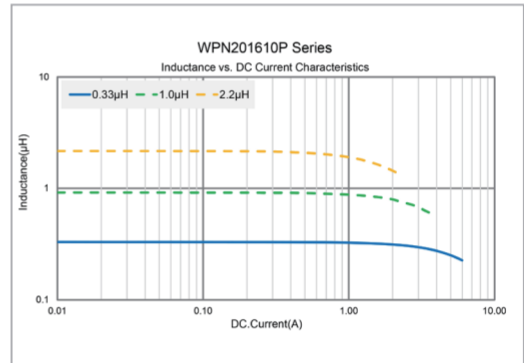

WPN201612S Series

Temperature vs. DC Current Characteristics

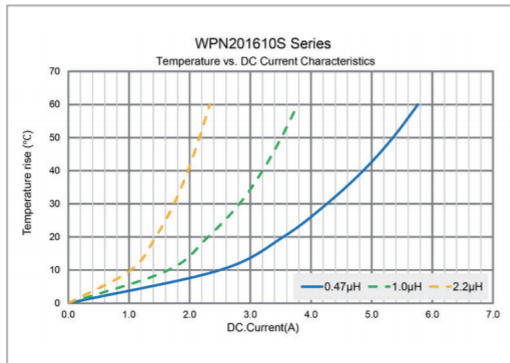

Inductance vs. DC Current Characteristics

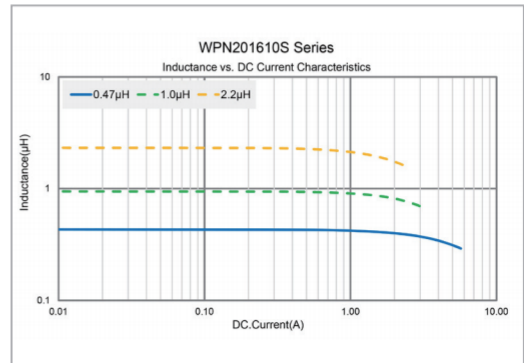

电气特性
Typical
Electrical
Characteristics

WPN201612H Series

Temperature vs. DC Current Characteristics

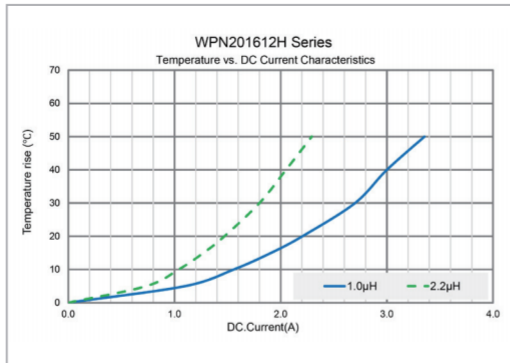

Inductance vs. DC Current Characteristics

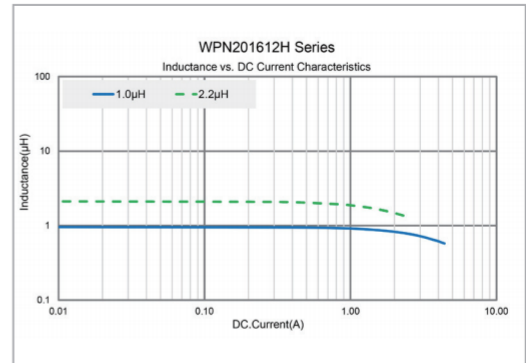

WPN252010H Series

Temperature vs. DC Current Characteristics

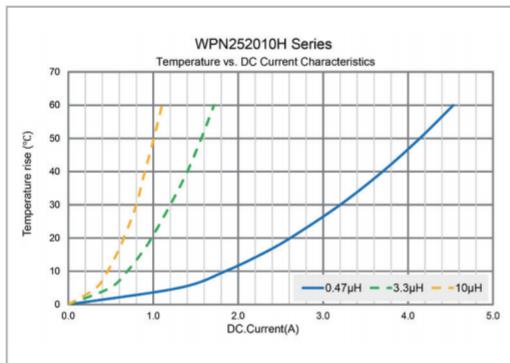

Inductance vs. DC Current Characteristics

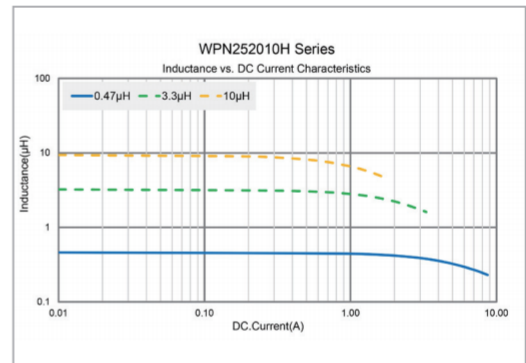

WPN252010HS Series

Temperature vs. DC Current Characteristics

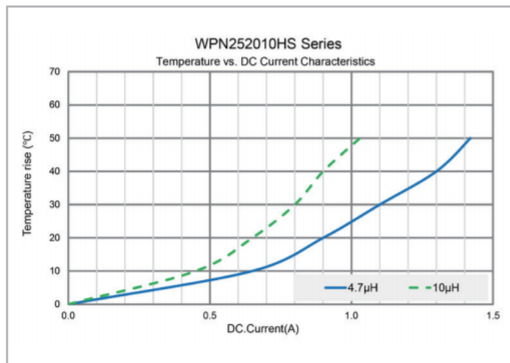

Inductance vs. DC Current Characteristics

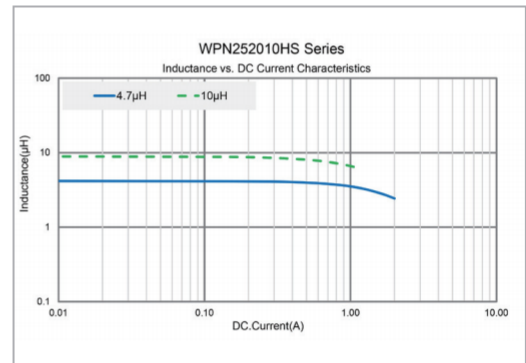

WPN252010U Series

Temperature vs. DC Current Characteristics

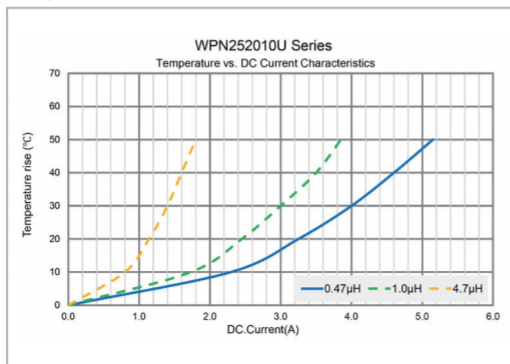

Inductance vs. DC Current Characteristics

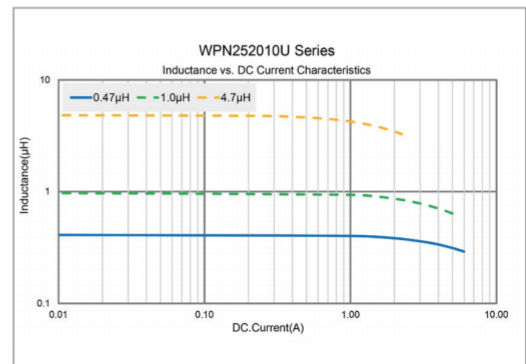

电气特性
Typical
Electrical
Characteristics

WPN252010F Series

Temperature vs. DC Current Characteristics

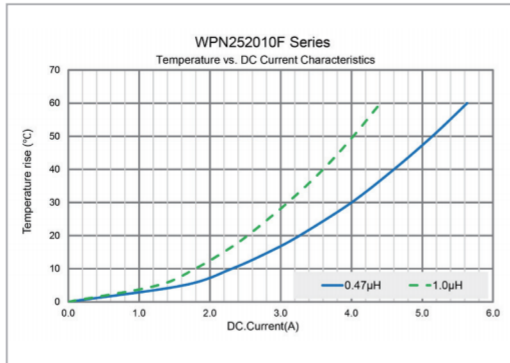

Inductance vs. DC Current Characteristics

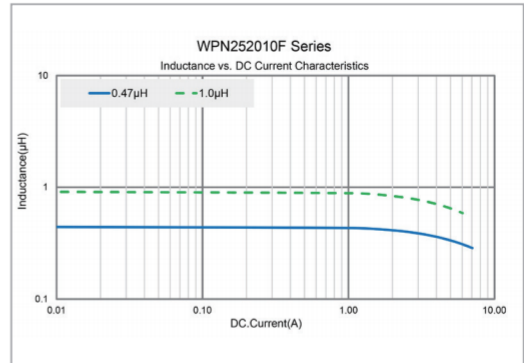

WPN252010P Series

Temperature vs. DC Current Characteristics

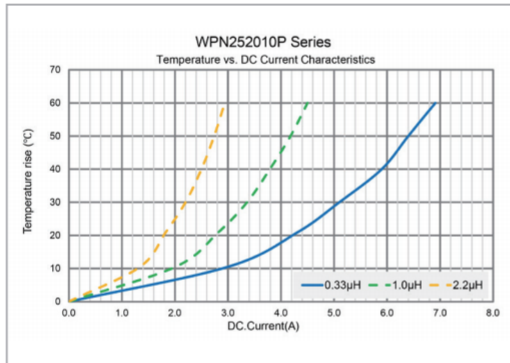

Inductance vs. DC Current Characteristics

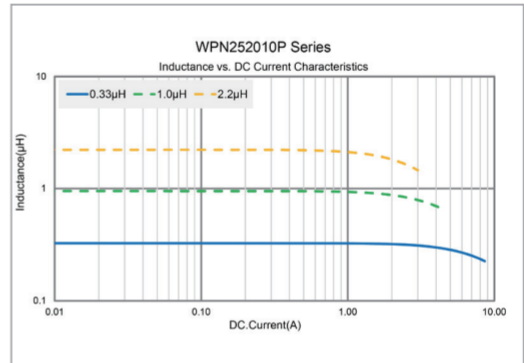

WPN252010S Series

Temperature vs. DC Current Characteristics

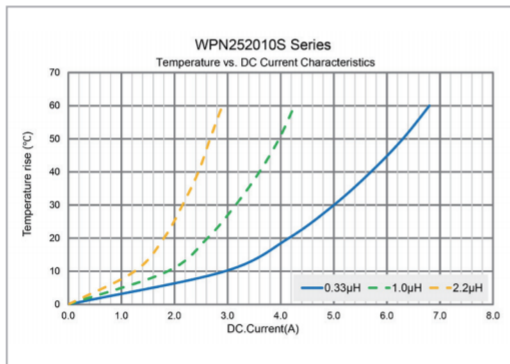

Inductance vs. DC Current Characteristics

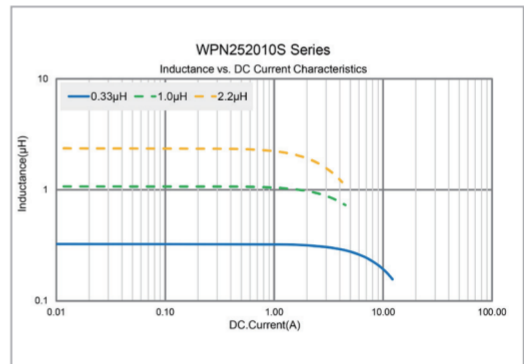

WPN252012H Series

Temperature vs. DC Current Characteristics

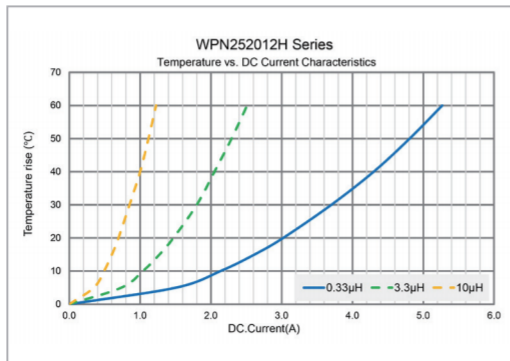

Inductance vs. DC Current Characteristics

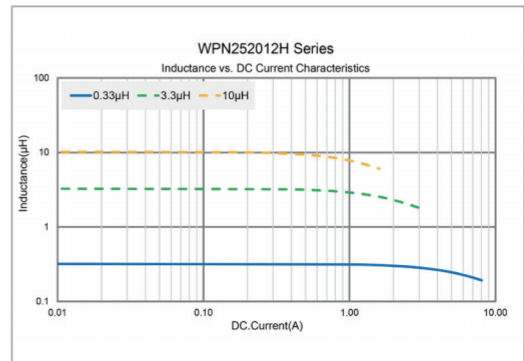

电气特性
Typical
Electrical
Characteristics

WPN252012HS Series

Temperature vs. DC Current Characteristics

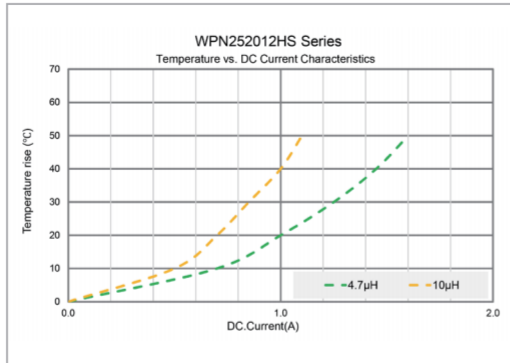

Inductance vs. DC Current Characteristics

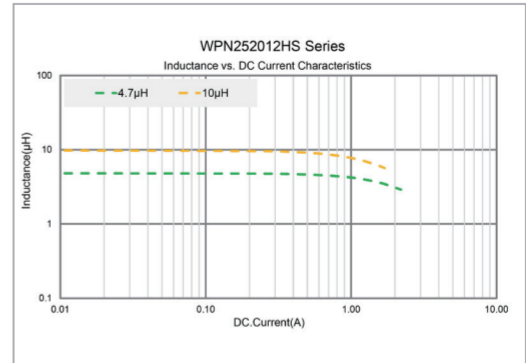

WPN252012E Series

Temperature vs. DC Current Characteristics

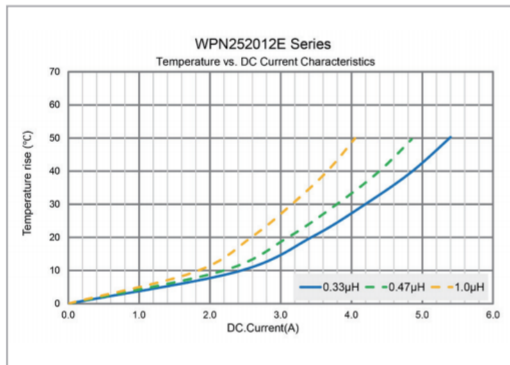

Inductance vs. DC Current Characteristics

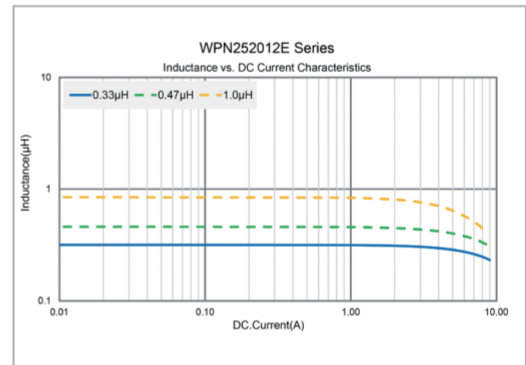

WPN252012S Series

Temperature vs. DC Current Characteristics

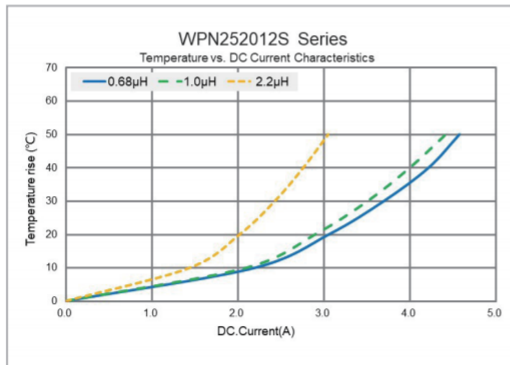

Inductance vs. DC Current Characteristics

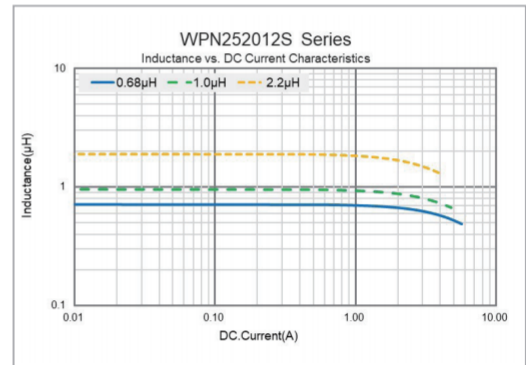

WPN3010HS Series

Temperature vs. DC Current Characteristics

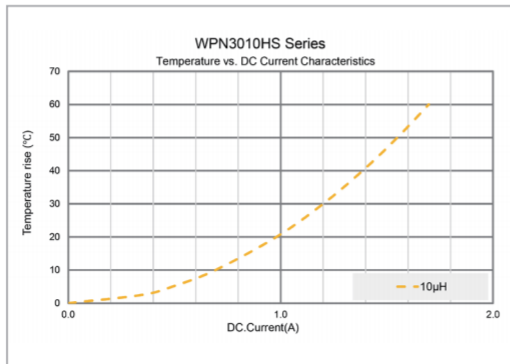

Inductance vs. DC Current Characteristics

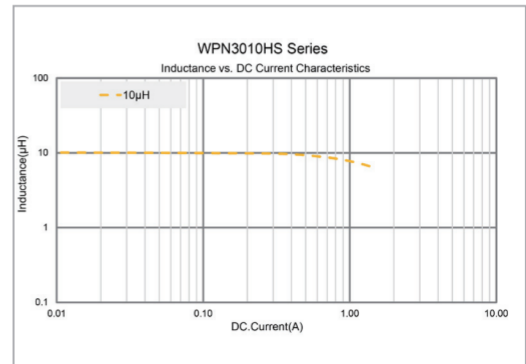

电气特性
Typical
Electrical
Characteristics

WPN3012H Series
Temperature vs. DC Current Characteristics

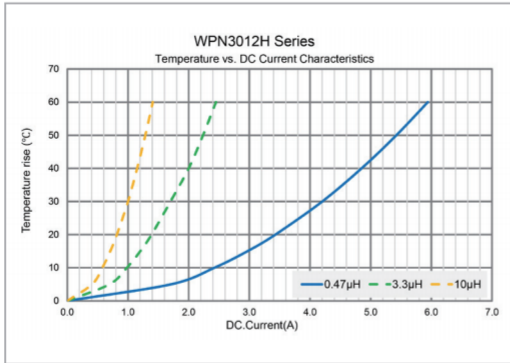

Inductance vs. DC Current Characteristics

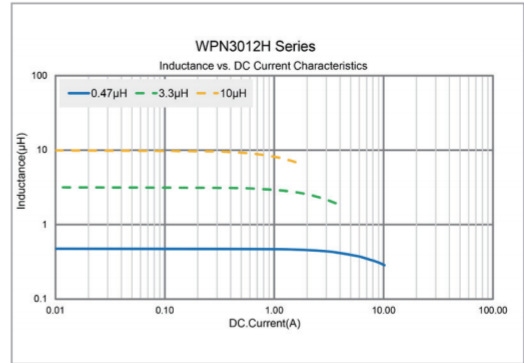

WPN3012HS Series
Temperature vs. DC Current Characteristics

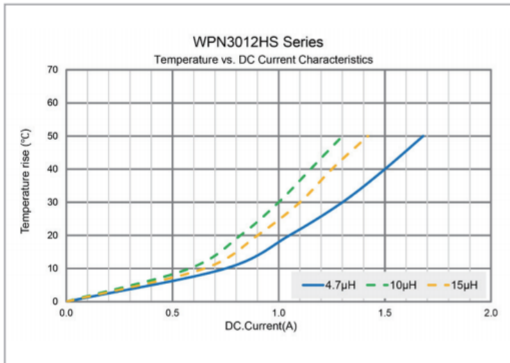

Inductance vs. DC Current Characteristics

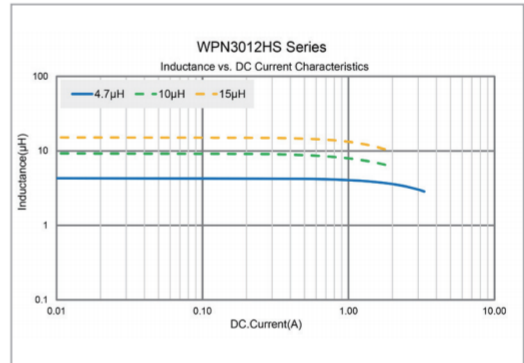

WPN4010HS Series
Temperature vs. DC Current Characteristics

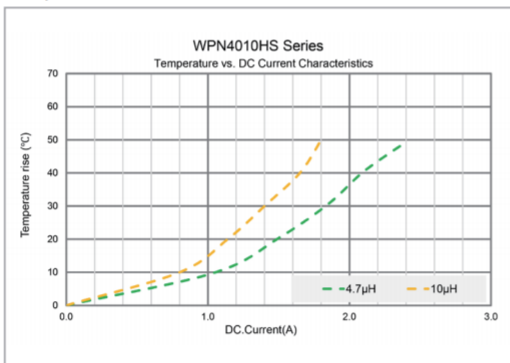

Inductance vs. DC Current Characteristics

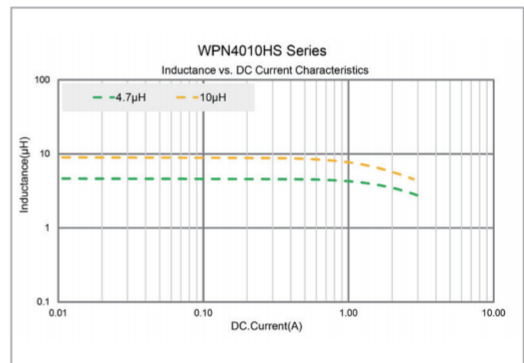

WPN4012H Series
Temperature vs. DC Current Characteristics

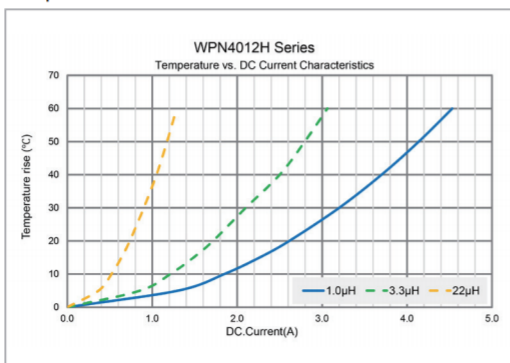

Inductance vs. DC Current Characteristics

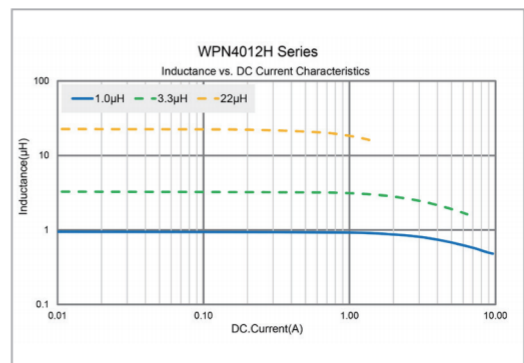

电气特性
Typical
Electrical
Characteristics

WPN4012HS Series

Temperature vs. DC Current Characteristics

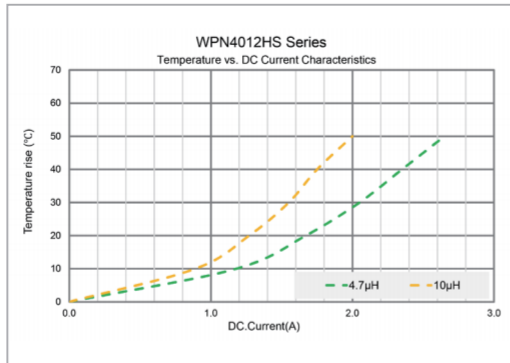

Inductance vs. DC Current Characteristics

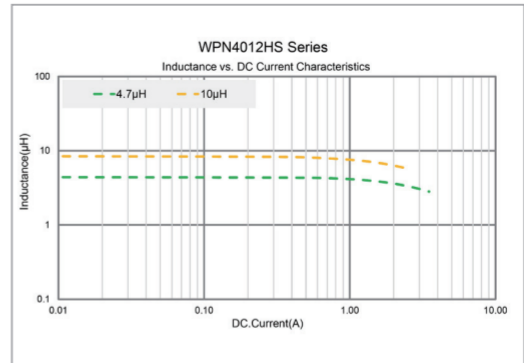

WPN4020H Series

Temperature vs. DC Current Characteristics

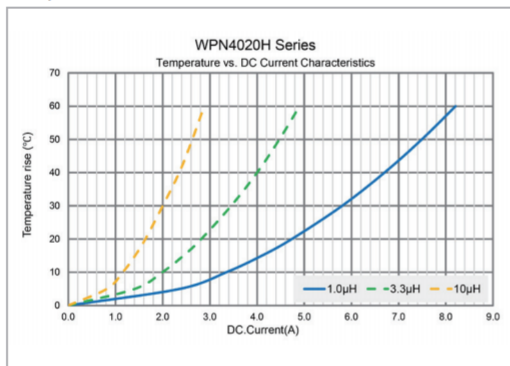

Inductance vs. DC Current Characteristics

