

DESCRIPTION

The MIE1W0505BGLVH is an isolated, regulated, DC/DC module. It can support 3V to 5.5V input voltage (V_{IN}) applications. With excellent load and line regulation, it supports up to 1W of output power (P_{OUT}).

The MIE1W0505BGLVH integrates power MOSFETs, transformer, and feedback (FB) circuit all in one chip, achieving excellent performance and saving size.

The MIE1W0505BGLVH supports a regulated output voltage (V_{OUT}). When V_{OUT} drops below the target voltage (3.3V or 5V), the IC begins switching, delivering power from the V_{IN} pin to the V_{OUT} pin until V_{OUT} reaches the target voltage again.

The device also integrates a V_{OUT} feedback block, which can regulate V_{OUT} without the need for a traditional optocoupler and a precision programmable reference IC. This small solution provides high reliability compared to traditional isolated power modules.

Full protection features include short-circuit protection (SCP) and over-temperature protection (OTP).

The MIE1W0505BGLVH is available in a small LGA-12 (4mmx5mm) package.

FEATURES

- 3V to 5.5V Input Voltage (V_{IN}) Operation Range
- Selectable 5V or 3.3V Output Voltage (V_{OUT})
 - 5V to 5V: $\geq 200\text{mA}$ Available Load Current (I_{LOAD})
 - 5V to 3.3V: $\geq 200\text{mA}$ Available I_{LOAD}
 - 3.3V to 3.3V: $\geq 75\text{mA}$ Available I_{LOAD}
- 2.5kV_{RMS} Isolation Voltage
- Supports Infinite Capacitive Load
- 0.4% Load Regulation
- 0.3% Line Regulation
- Continuous Short-Circuit Protection (SCP)
- Over-Temperature Protection (OTP)
- CB Certification According to IEC 62368-1
- Meets EN55032 Class B Emissions
- -40°C to $+125^{\circ}\text{C}$ Operating Temperature Range
- Available in an LGA-12 (4mmx5mm) Package

APPLICATIONS

- Industrial Automation Systems
- Isolated Bias Power for Digital Isolators
- Isolated Power for Isolated RS-485, RS-422, and CAN Interfaces
- Isolated Sensor Power Supplies
- Telecom and Network Devices (5G RRUs, Industrial CPEs, Network Gateways, etc.)

All MPS parts are lead-free, halogen-free, and adhere to the RoHS directive. For MPS green status, please visit the MPS website under Quality Assurance. "MPS", the MPS logo, and "Simple, Easy Solutions" are trademarks of Monolithic Power Systems, Inc. or its subsidiaries.

TYPICAL APPLICATION

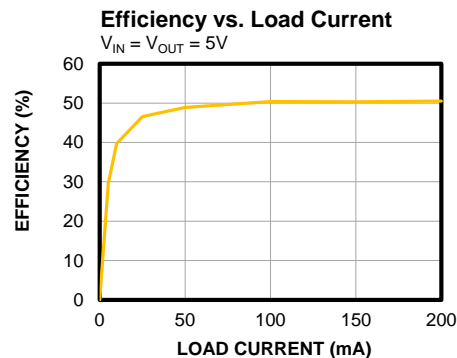
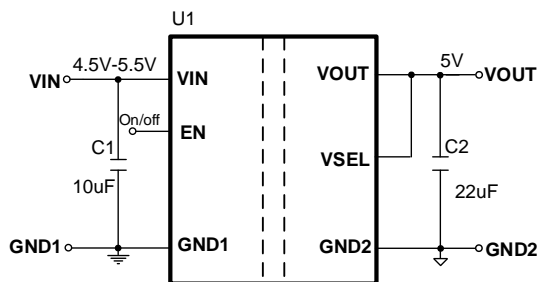

ORDERING INFORMATION

Part Number*	Package	Top Marking	MSL Rating
MIE1W0505BGLVH-3R	LGA-12 (4mmx5mm)	See Below	3

* For Tape & Reel, add suffix -Z (e.g. MIE1W0505BGLVH-3R-Z).

TOP MARKING

MPSYWW
1W0505
LLLLLL
BH

MPS: MPS prefix
 Y: Year code
 WW: Week code
 1W0505: Part number
 LLLLLL: Lot number
 BH: Part number suffix

PACKAGE REFERENCE

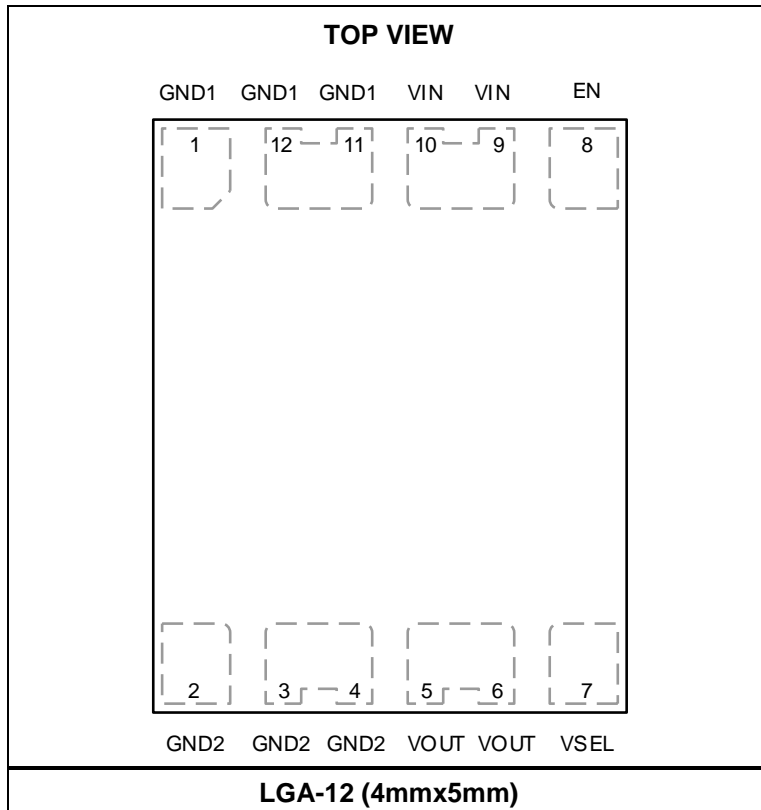

PIN FUNCTIONS

Pin #	Name	Description
1, 11, 12	GND1	Power ground side 1.
2, 3, 4	GND2	Power ground side 2.
5, 6	VOUT	Power output pin. It is recommended to connect a 22μF capacitor and a 0.1μF capacitor between VOUT and GND2 (pins 3 and 4) to decrease the output voltage (V _{OUT}) ripple and noise.
7	VSEL	Output voltage setting pin. For a 5V output, connect the VSEL pin to VOUT or float this pin. For a 3.3V output, connect the VSEL pin to GND2. Do not bias VSEL with another power source.
8	EN	Enable pin. Pull the EN pin high to enable the MIE1W0505BGLVH; pull it low to disable the MIE1W0505BGLVH. Do not leave this pin floating.
9, 10	VIN	Power input pin. Connect the VIN pin to a 3V to 5.5V power supply. Connect a 10μF capacitor and a 0.1μF capacitor between VIN and GND1 (pins 11 and 12) to stabilize the IC.

ABSOLUTE MAXIMUM RATINGS ⁽¹⁾

VIN/EN to GND1	-0.3V to +6.5V
VOUT/VSEL to GND2.....	-0.3V to +6.5V
Continuous power dissipation (T _A = 25°C) ⁽²⁾ ⁽⁴⁾	1.78W
Junction temperature (T _J)	150°C
Lead temperature	260°C
Storage temperature.....	-65°C to +150°C

ESD Ratings

Human body model (HBM)	±5000V
Charged-device model (CDM)	±2000V

Recommended Operating Conditions ⁽³⁾

Input voltage (V _{IN})	3V to 5.5V
Output voltage (V _{OUT})	5/3.3V
Operating junction temp (T _J)	-40°C to +125°C

Thermal Resistance

θ_{JA} θ_{JC}

LGA-12 (4mmx5mm)		
EV1W0505B-LVH-00A ⁽⁴⁾	70.....	22... °C/W
JESD51-7 ⁽⁵⁾	61	19... °C/W

Notes:

- Exceeding these ratings may damage the device.
- The maximum allowable power dissipation is a function of the maximum junction temperature T_J (MAX), the junction-to-ambient thermal resistance θ_{JA}, and the ambient temperature T_A. The maximum allowable continuous power dissipation at any ambient temperature is calculated by P_D (MAX) = (T_J (MAX) - T_A) / θ_{JA}. Exceeding the maximum allowable power dissipation can produce an excessive die temperature, which may cause the regulator to go into thermal shutdown. Internal thermal shutdown circuitry protects the device from permanent damage.
- The device is not guaranteed to function outside of its operating conditions.
- Measured on the EV1W0505B-LVH-00A (51mmx51mm), a 1oz, 2-layer PCB.
- The value of θ_{JA} given in this table is only valid for comparison with other packages and cannot be used for design purposes. These values were calculated in accordance with JESD51-7, and simulated on a specified JEDEC board. They do not represent the performance obtained in an actual application.

ELECTRICAL CHARACTERISTICS

$V_{IN} = 5V$, $V_{OUT} = 5V$, $C_{IN} = 0.1\mu F + 10\mu F$, $C_{OUT} = 0.1\mu F + 22\mu F$, $T_J = -40^{\circ}C$ to $+125^{\circ}C$ ⁽⁶⁾, typical values are tested at $T_J = 25^{\circ}C$, unless otherwise noted.

Parameter	Symbol	Condition	Min	Typ	Max	Units
Power Supply						
V_{IN} under-voltage lockout (UVLO) rising threshold	$V_{IN_UVLO_R}$	V_{IN} rising	2.45	2.6	2.75	V
V_{IN} UVLO threshold hysteresis	V_{IN_HYS}			220		mV
Shutdown current	I_{SD}	$V_{IN} = 5.5V$, $V_{EN} = 0V$, measured on the V_{IN} pin		7	50	μA
Input current	I_{IN}	Load = 0A		8	11	mA
		Load = 0.2A		395	450	mA
EN input high threshold					2	V
EN input voltage low threshold			0.4			V
EN input current leakage		EN connected to GND1	-7	-5		μA
Output voltage accuracy	V_{OUT_ACC}	$V_{IN} = 4.5V$ to $5.5V$, $I_{OUT} = 0A$	4.85	5	5.15	V
Load regulation		Load = 0A to 0.2A		0.4	2	%
Line regulation		$V_{IN} = 4.5V$ to $5.5V$, load = 0.2A		0.3	2	%
Efficiency ⁽⁷⁾		Load = 0.2A		50.5		%
Ripple		$T_A = 25^{\circ}C$, 20MHz bandwidth		60	100	mV
Isolated voltage	V_{ISO}	Short all primary pins and all secondary pins as a two-terminal part, test time = 60s, qualified test	2.5			kV _{RMS}
		Short all primary pins and all secondary pins as a two-terminal part, test time = 1s, production test, 100% test	3			kV _{RMS}
Input to output capacitance ⁽⁷⁾	C_{I-O}	Short all primary pins and all secondary pins as a two-terminal part, measuring frequency = 1MHz		5		pF
Input to output resistance ⁽⁷⁾	R_{I-O}	Short all primary pins and all secondary pins as a two-terminal part, test voltage = 500V _{DC}	50			G Ω
Static common-mode transient immunity (CMTI) ⁽⁷⁾	CMTI		100			kV/ μs
Thermal Shutdown ⁽⁷⁾						
Thermal shutdown temperature	T_{SD}			150		$^{\circ}C$
Thermal shutdown hysteresis	T_{SD-HYS}			20		$^{\circ}C$

ELECTRICAL CHARACTERISTICS (continued)

$V_{IN} = 5V$, $V_{OUT} = 3.3V$, $C_{IN} = 0.1\mu F + 10\mu F$, $C_{OUT} = 0.1\mu F + 22\mu F$, $T_J = -40^{\circ}C$ to $+125^{\circ}C$ ⁽⁶⁾, typical values are tested at $T_J = 25^{\circ}C$, unless otherwise noted.

Parameter	Symbol	Condition	Min	Typ	Max	Units
Power Supply						
Shutdown current	I_{SD}	$V_{IN} = 5.5V$, $V_{EN} = 0V$, measured on the VIN pin		7	50	μA
Input current	I_{IN}	Load = 0A		5	8	mA
		Load = 0.2A		354	430	mA
EN input current leakage		EN connected to GND1	-7	-5		μA
Output voltage accuracy	V_{OUT_ACC}	$V_{IN} = 4.5V$ to $5.5V$, $I_{OUT} = 0A$	3.18	3.3	3.42	V
Load regulation		Load = 0A to 0.2A		0.4	2	%
Line regulation		$V_{IN} = 4.5V$ to $5.5V$, load = 0.2A		0.2	2	%
Efficiency ⁽⁷⁾		Load = 0.2A		37		%
Ripple		$T_A = 25^{\circ}C$, 20MHz bandwidth		50	90	mV

ELECTRICAL CHARACTERISTICS (continued)

$V_{IN} = 3.3V$, $V_{OUT} = 3.3V$, $C_{IN} = 0.1\mu F + 10\mu F$, $C_{OUT} = 0.1\mu F + 22\mu F$, $T_J = -40^{\circ}C$ to $+125^{\circ}C$ ⁽⁶⁾, typical values are tested at $T_J = 25^{\circ}C$, unless otherwise noted.

Parameter	Symbol	Condition	Min	Typ	Max	Units
Power Supply						
Shutdown current	I_{SD}	$V_{EN} = 0V$, measured on the VIN pin		5	30	μA
Input current	I_{IN}	Load = 0A		5	8	mA
		Load = 0.075A		150	190	mA
EN input current leakage		EN connected to GND1	-5	-3.3		μA
Output voltage accuracy	V_{OUT_ACC}	$V_{IN} = 3V$ to $3.6V$, $I_{OUT} = 0A$	3.18	3.3	3.42	V
Load regulation		Load = 0A to 0.075A		0.3	1.8	%
Line regulation		$V_{IN} = 3V$ to $3.6V$, load = 0.075A		0.2	1.5	%
Efficiency ⁽⁷⁾		Load = 0.075A		50		%
Ripple		$T_A = 25^{\circ}C$, 20MHz bandwidth		30	60	mV

Notes:

- 6) Guaranteed by over-temperature (OT) correlation. Not tested in production.
 7) Guaranteed by sample characterization. Not tested in production.

TYPICAL CHARACTERISTICS

$V_{IN} = 5V$, $V_{OUT} = 5V$, $C_{IN} = 0.1\mu F + 10\mu F$, $C_{OUT} = 0.1\mu F + 22\mu F$, $T_A = 25^\circ C$, unless otherwise noted.

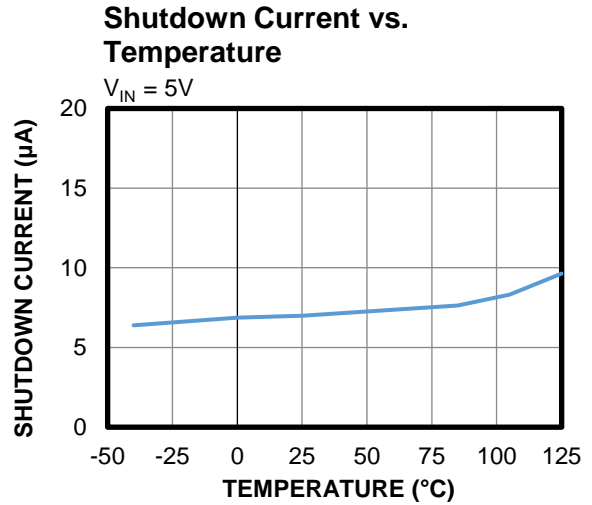
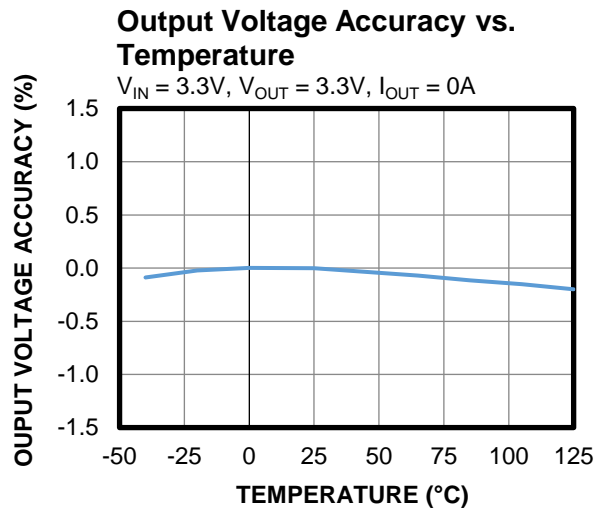
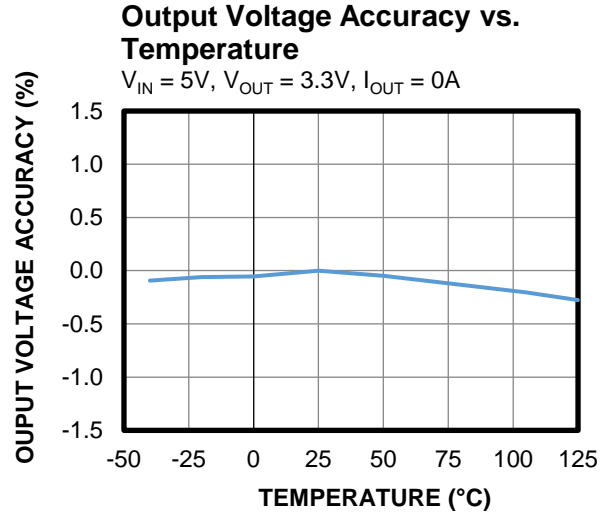
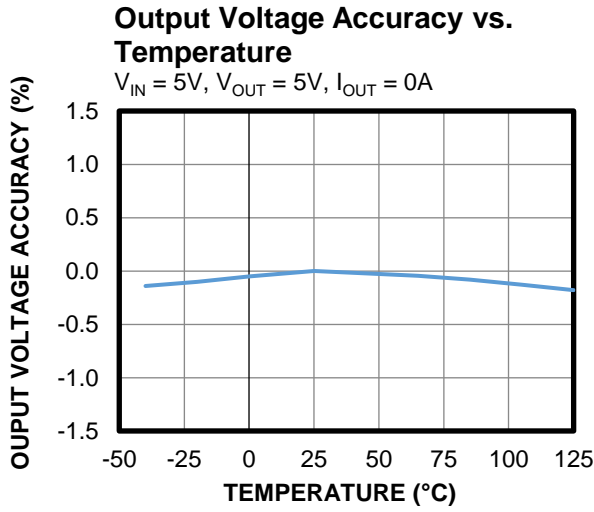

TYPICAL PERFORMANCE CHARACTERISTICS

$V_{IN} = 5V$, $V_{OUT} = 5V$, $C_{IN} = 0.1\mu F + 10\mu F$, $C_{OUT} = 0.1\mu F + 22\mu F$, $T_A = 25^\circ C$, unless otherwise noted.

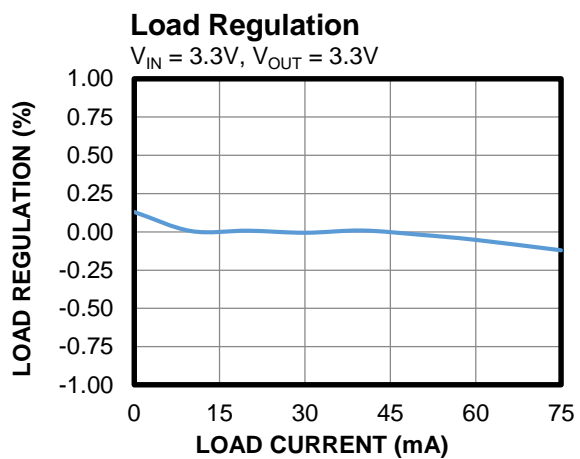
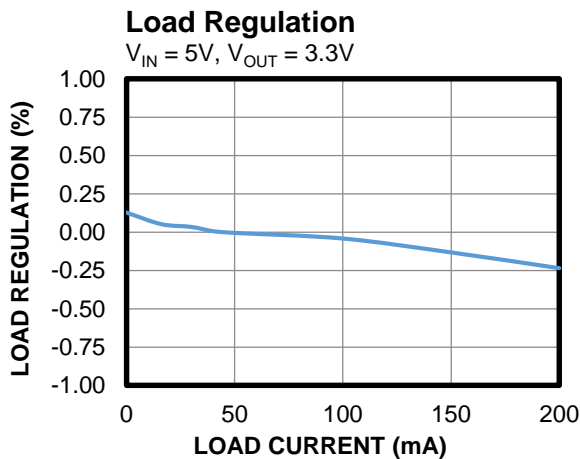
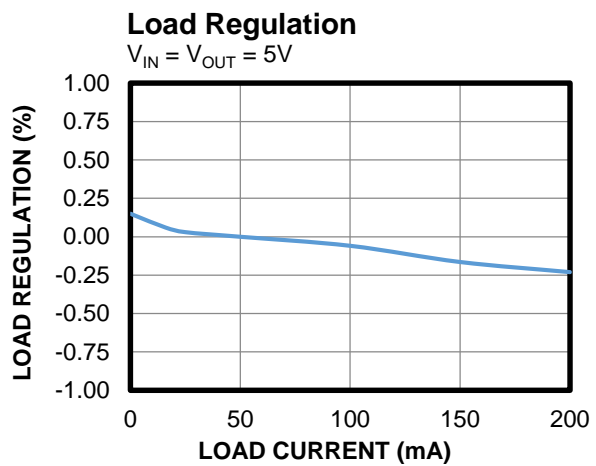
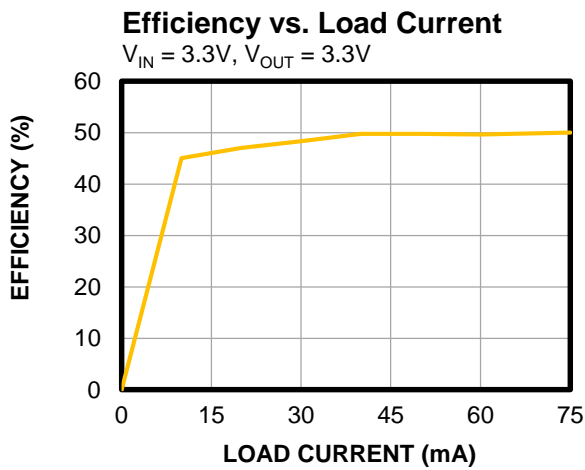
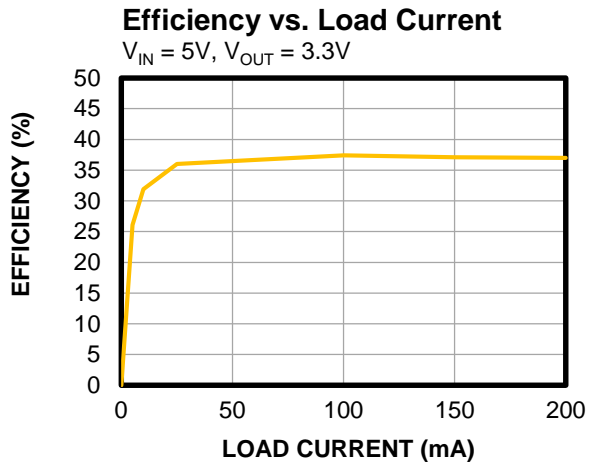
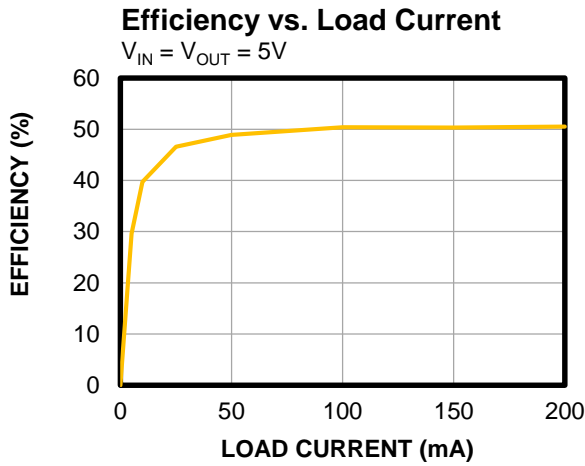

TYPICAL PERFORMANCE CHARACTERISTICS (continued)

$V_{IN} = 5V$, $V_{OUT} = 5V$, $C_{IN} = 0.1\mu F + 10\mu F$, $C_{OUT} = 0.1\mu F + 22\mu F$, $T_A = 25^\circ C$, unless otherwise noted.

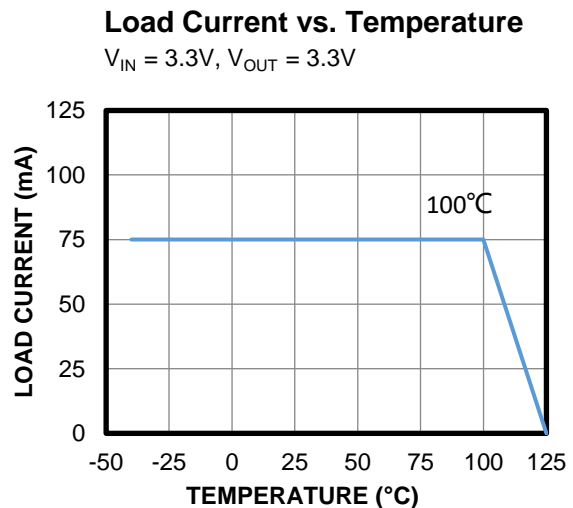
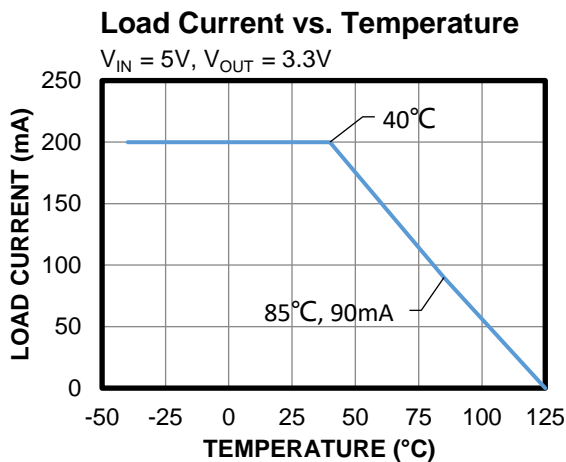
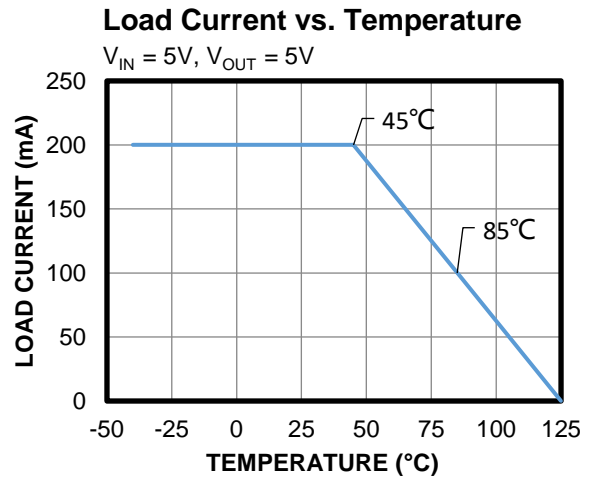
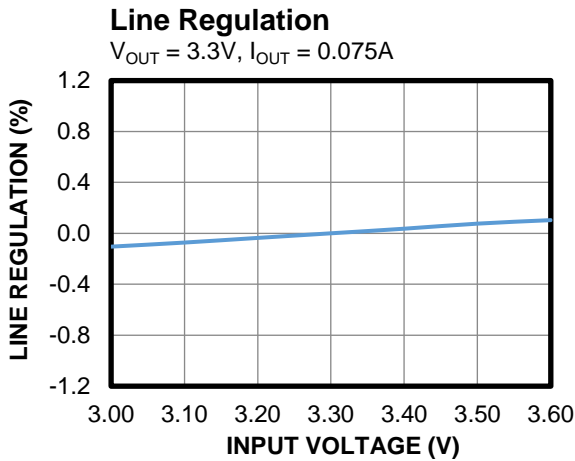
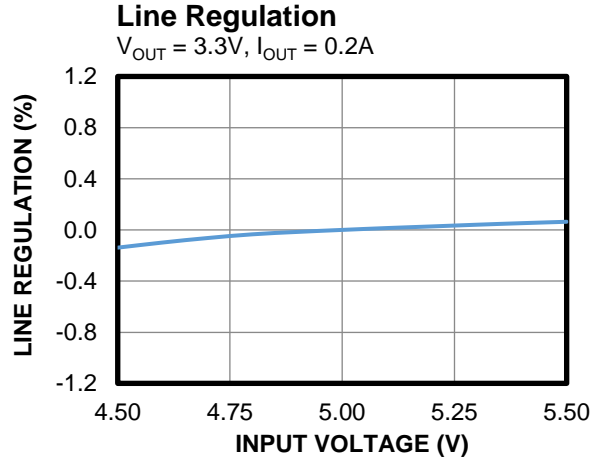
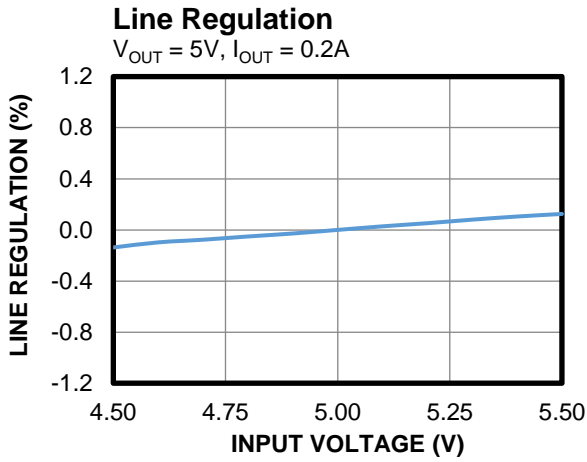

TYPICAL PERFORMANCE CHARACTERISTICS (continued)

$V_{IN} = 5V$, $V_{OUT} = 5V$, $C_{IN} = 0.1\mu F + 10\mu F$, $C_{OUT} = 0.1\mu F + 22\mu F$, $T_A = 25^\circ C$, unless otherwise noted.

V_{OUT} Ripple
I_{OUT} = 0.2A

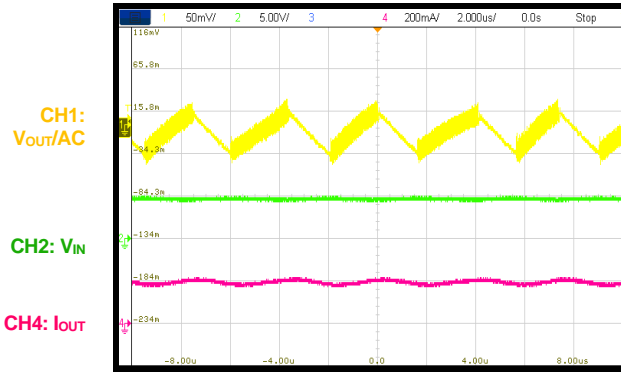

Load Transient
I_{OUT} = 0A to 0.2A

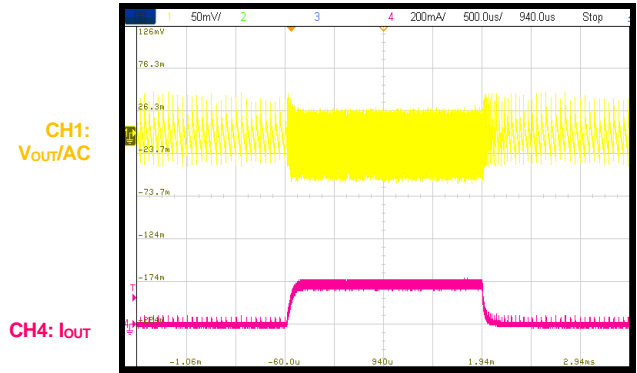

Start-Up through VIN
I_{OUT} = 0.2A

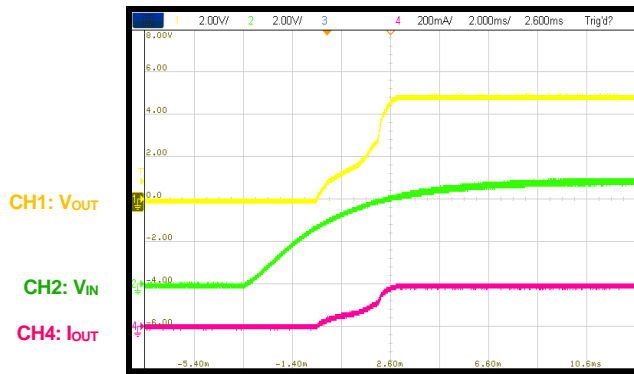

Shutdown through VIN
I_{OUT} = 0.2A

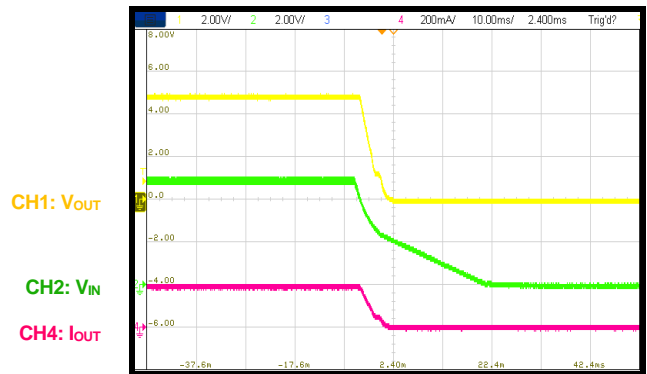

Start-Up through EN
I_{OUT} = 0.2A

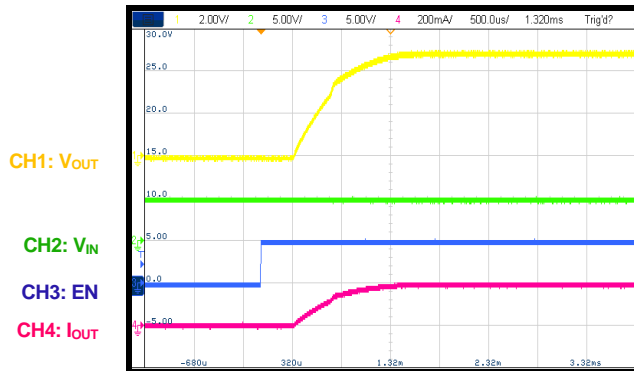

Shutdown through EN
I_{OUT} = 0.2A

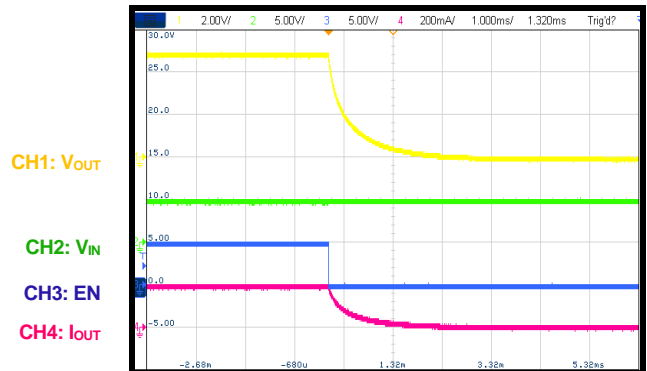

TYPICAL PERFORMANCE CHARACTERISTICS *(continued)*

$V_{IN} = 5V$, $V_{OUT} = 3.3V$, $C_{IN} = 0.1\mu F + 10\mu F$, $C_{OUT} = 0.1\mu F + 22\mu F$, $T_A = 25^\circ C$, unless otherwise noted.

V_{OUT} Ripple
 $I_{OUT} = 0.2A$

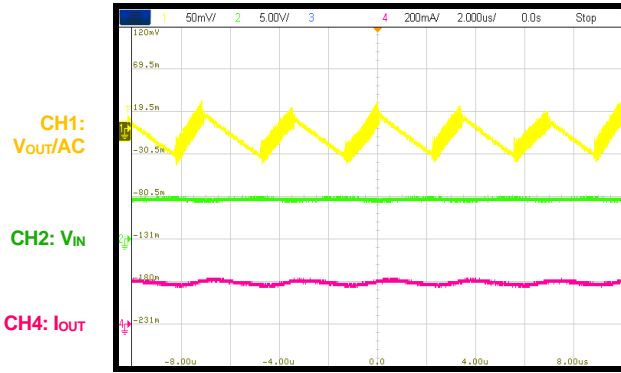

Load Transient
 $I_{OUT} = 0A$ to $0.2A$

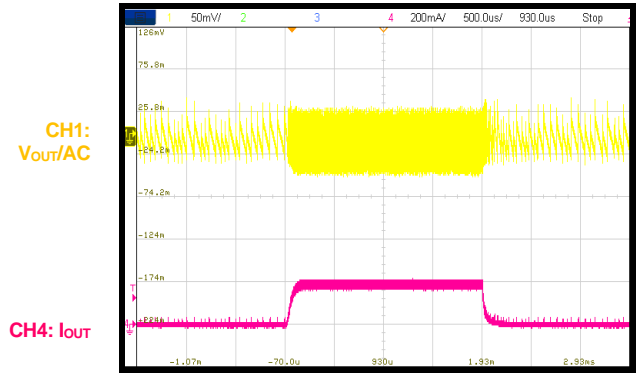

Start-Up through V_{IN}
 $I_{OUT} = 0.2A$

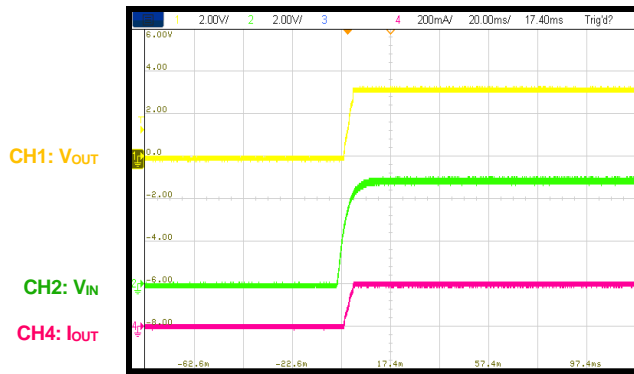

Shutdown through V_{IN}
 $I_{OUT} = 0.2A$

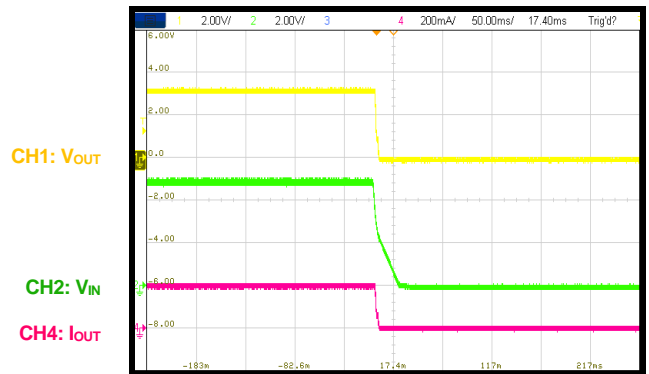

Start-Up through EN
 $I_{OUT} = 0.2A$

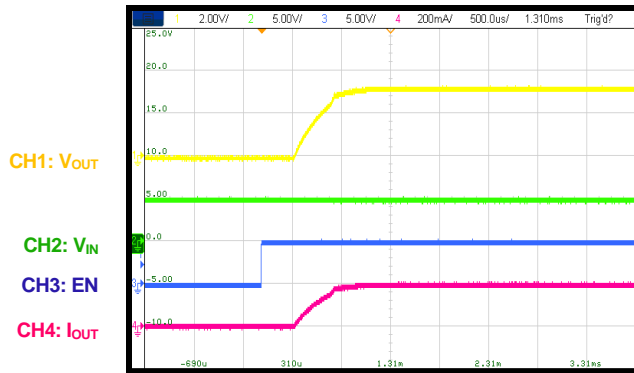

Shutdown through EN
 $I_{OUT} = 0.2A$

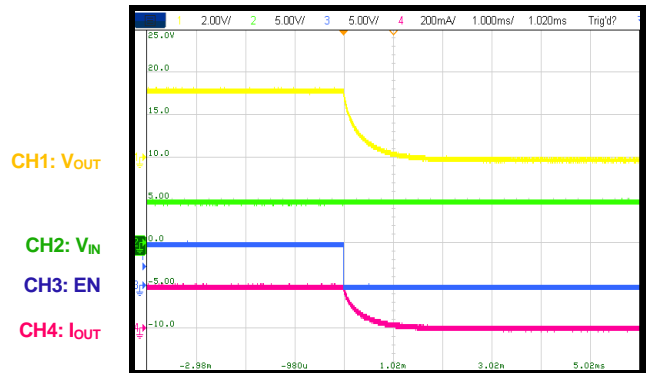

FUNCTIONAL BLOCK DIAGRAM

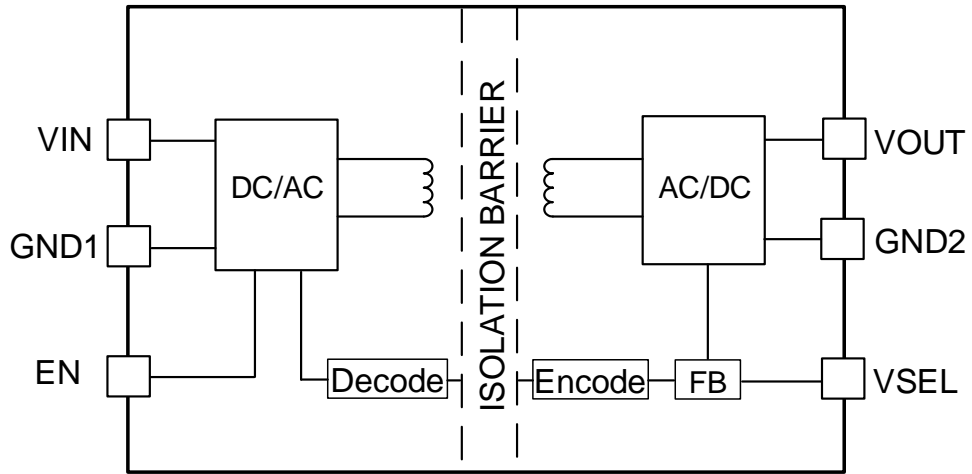

Figure 1: Functional Block Diagram

OPERATION

The MIE1W0505BGLVH is a regulated, isolated DC/DC module that can support 3V to 5.5V input voltage (V_{IN}) applications across a -40°C to $+125^{\circ}\text{C}$ operating temperature range. It has excellent load and line regulation, and supports up to 1W of output power (P_{OUT}).

Isolation Power Conversion

The MIE1W0505BGLVH integrates power MOSFETs, transformer, and feedback (FB) circuit all in one chip, making it a high-performance, small-sized solution.

If the output voltage (V_{OUT}) is below the target voltage (3.3V or 5V), the IC starts switching to deliver power from V_{IN} to V_{OUT} . If V_{OUT} exceeds the target voltage, the device stops switching.

Setting the Output Voltage

To set V_{OUT} to 5V, float the VSEL pin or connect it to VOUT. The VOUT pin can output a 200mA load with a 4.5V to 5.5V V_{IN} range.

To set V_{OUT} to 3.3V, connect the VSEL to GND2. The VOUT pin can output a 200mA load with a 4.5V to 5.5V V_{IN} range, or a 75mA load with a 3V to 3.6V V_{IN} range. VSEL logic is locked during start-up. After start-up, V_{OUT} is fixed even if the VSEL logic is changed.

Under-Voltage Lockout Protection (UVLO)

The MIE1W0505BGLVH has input under-voltage lockout (UVLO) protection to ensure reliable P_{OUT} . The MIE1W0505BGLVH starts up once V_{IN} exceeds the UVLO rising threshold. The device shuts down when V_{IN} drops below the UVLO falling threshold. This function prevents the device from operating at an insufficient voltage. UVLO is a non-latch protection.

Enable (EN)

The EN pin enables and disables the MIE1W0505BGLVH. When a voltage above 2V is applied to the EN pin and V_{IN} is above the V_{IN} UVLO threshold, the MIE1W0505BGLVH enables all functions and begins switching. If the EN voltage (V_{EN}) falls below its lower threshold and (0.4V), switching is disabled. For automatic start-up, connect the EN pin to V_{IN} directly or through a resistor divider.

Power Converter Soft Start (SS) and Short-Circuit Protection (SCP)

To avoid overshoot and inrush current during start-up, the MIE1W0505BGLVH has a built-in internal soft start (SS) function that gradually ramps up the output voltage (V_{OUT}).

The MIE1W0505BGLVH starts up in constant current (CC) charging mode. In this mode, the current limit folds back, and I_{OUT} CC charges the output capacitor (C_{OUT}) until V_{OUT} rises to about 2.7V. After the CC charging period, the MIE1W0505BGLVH's current limit returns to normal (does not fold back), with higher I_{OUT} capability. Such features guarantee infinite capacitive load.

During an overload or output short-circuit condition, V_{OUT} drops due to the internal current limit. Once V_{OUT} drops below about 2.2V, the MIE1W0505BGLVH enters CC charging mode. After the over-current (OC) or short-circuit is condition removed and V_{OUT} rises to about 2.7V, the MIE1W0505BGLVH resumes normal operation.

Over-Temperature Protection (OTP)

The MIE1W0505BGLVH integrates one temperature monitoring circuit. If the junction temperature (T_J) exceeds 150°C , the MIE1W0505BGLVH shuts down. Once the temperature drops below 130°C , the device restarts and resumes normal operation.

APPLICATION INFORMATION

Selecting the Input and Output Capacitors

For stable operation, connect decoupling capacitors between the VIN and GND1 pins at the input side, and between the VOUT and GND2 pins at the output side. Place these decoupling capacitors as close to VIN and VOUT as possible. It is recommended to add one 10 μ F and one 0.1 μ F ceramic capacitor at the input, and to add one 22 μ F and one 0.1 μ F ceramic capacitor at output side. The higher-value capacitor is used to make the V_{OUT} ripple suitable, and the smaller one is used to filter high-frequency noise.

PCB Layout Guidelines

Efficient PCB layout is critical for stable operation. A 4-layer layout is recommended for good EMI performance. For the best results, refer to Figure 2 and follow the guidelines below:

1. For safety, the primary side and secondary side should be physically separated. Ensure that the creepage/clearance meets the standards for the specified application.
2. To reduce output noise, minimize the loop area between VIN, the input capacitor, and GND1, as well as between VOUT, the output capacitor, and GND2.
3. Place enough copper and vias around the GND1 pins to improve thermal performance.
4. Do not place large copper areas on the GND2 and VOUT pins on the top layer, as doing so will make EMI worse. The smaller the copper areas on VOUT and GND2, the better the EMI performance.
5. Build a low-ESL overlap Y-capacitor to bypass EMI noise. Place sufficient vias on the GND1 and GND2 copper planes to reduce the Y-capacitor's ESL.
6. It is recommended to place the external Y-capacitor for EMI debugging. An SMD package for the Y-capacitor is recommended due to its lower ESL.

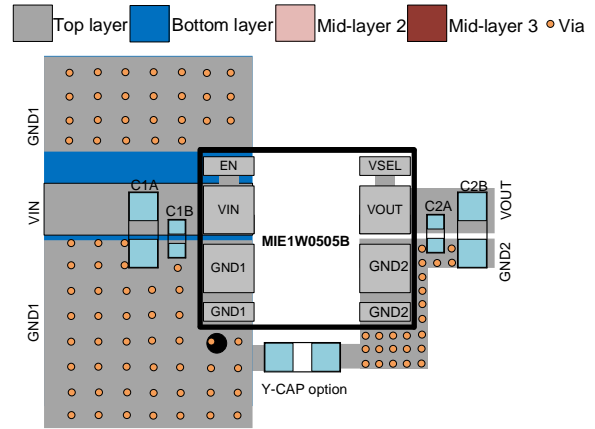

Top Layer and Bottom Layer

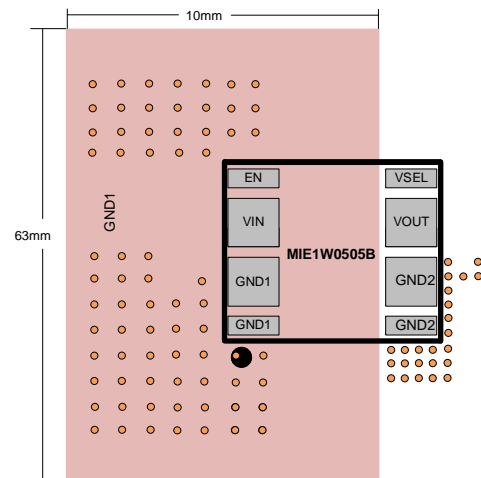

Mid-Layer 2

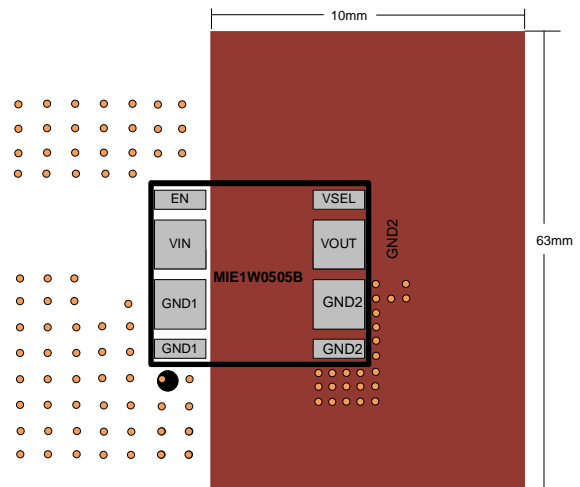

Mid-Layer 3

Figure 2: Recommended PCB Layout

TYPICAL APPLICATION CIRCUITS

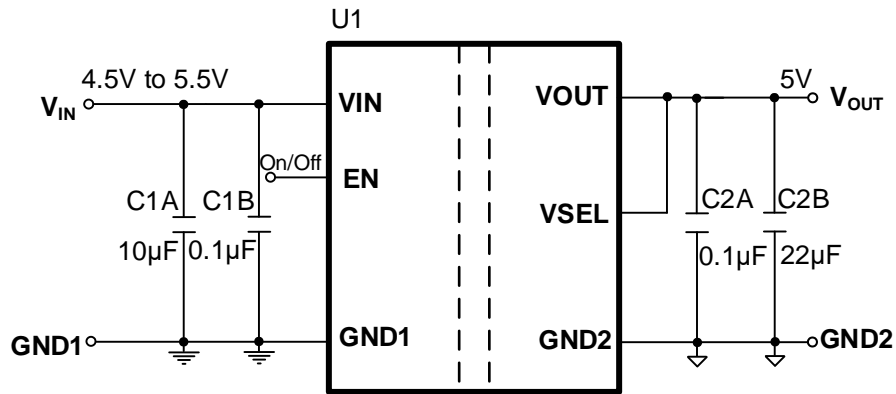

Figure 3: Typical Application Circuit with 5V Output

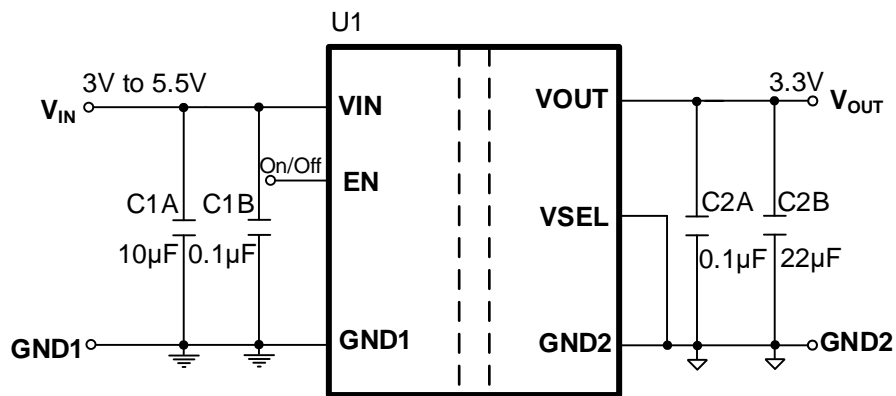
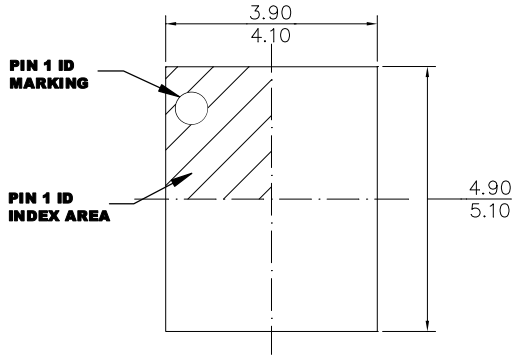

Figure 4: Typical Application Circuit with 3.3V Output

PACKAGE INFORMATION

LGA-12 (4mmx5mm)



TOP VIEW

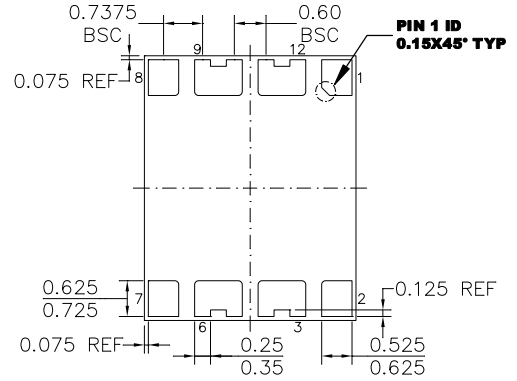

BOTTOM VIEW

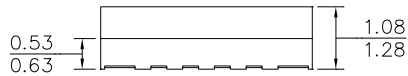

SIDE VIEW

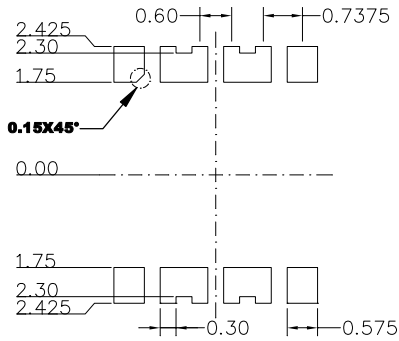

RECOMMENDED LAND PATTERN

NOTE:

- 1) ALL DIMENSIONS ARE IN MILLIMETERS.**
- 2) LEAD COPLANARITY SHALL BE 0.10 MILLIMETERS MAX.**
- 3) JEDEC REFERENCE IS MO-303.**
- 4) DRAWING IS NOT TO SCALE.**

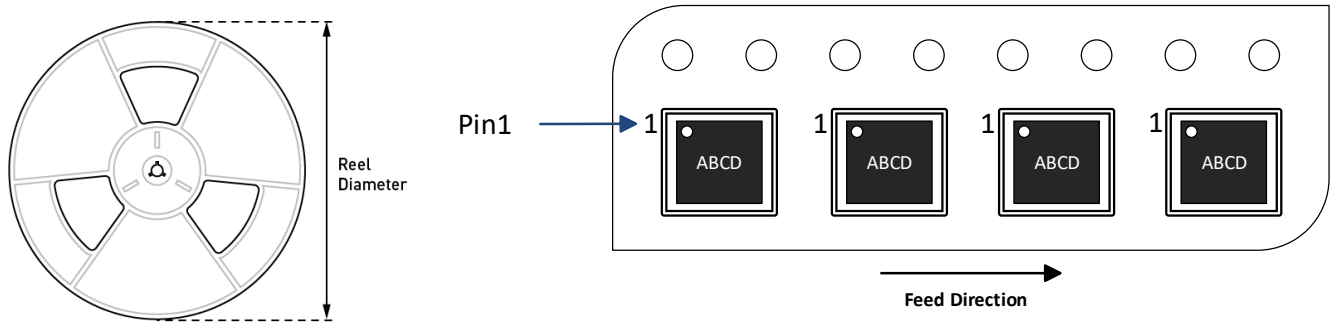
CARRIER INFORMATION

Part Number	Package Description	Quantity /Reel	Quantity /Tube	Quantity /Tray	Reel Diameter	Carrier Tape Width	Carrier Tape Pitch
MIE1W0505BGLVH-3R-Z	LGA-12 (4mmx5mm)	2500	N/A	N/A	13in	12mm	8mm



REVISION HISTORY

Revision #	Revision Date	Description	Pages Updated
1.0	6/28/2024	Initial Release	-

Notice: The information in this document is subject to change without notice. Please contact MPS for current specifications. Users should warrant and guarantee that third-party Intellectual Property rights are not infringed upon when integrating MPS products into any application. MPS will not assume any legal responsibility for any said applications.