

IR MOSFET-DirectFET™

IRF7749L1TRPbF

Quality Requirement Category: Industrial

Applications

- RoHS Compliant, Halogen Free
- Lead-Free (Qualified up to 260°C Reflow)
- Ideal for High Performance Isolated Converter Primary Switch Socket
- Optimized for Synchronous Rectification
- Low Conduction Losses
- High Cdv/dt Immunity
- Low Profile (<0.7mm)
- Dual Sided Cooling Compatible
- Compatible with existing Surface Mount Techniques

DirectFET™ N-Channel Power MOSFET

V_{DSS}	60V
R_{DS(on)} typ. @ V_{GS} = 10V	1.1mΩ
R_{DS(on)} max @ V_{GS} = 10V	1.5mΩ
I_D (Silicon Limited)	345A ⑦
I_D (Package Limited)	375A ①

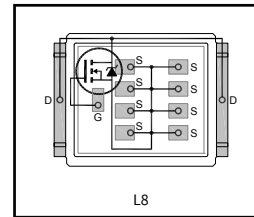

G	D	S
Gate	Drain	Source

Base part number	Package Type	Standard Pack		Orderable Part Number
		Form	Quantity	
IRF7749L1TRPbF	DirectFET™ Large Can (LA)	Tape and Reel	4000	IRF7749L1TRPbF

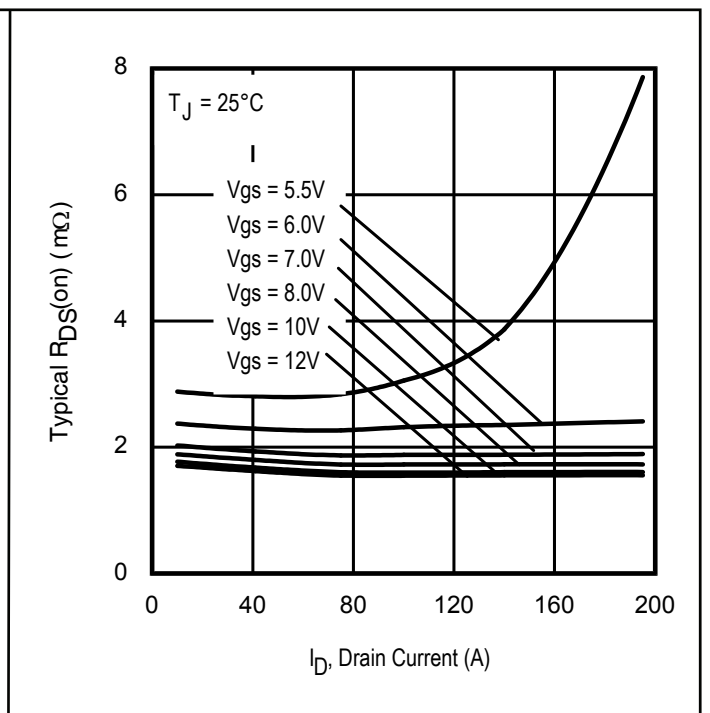
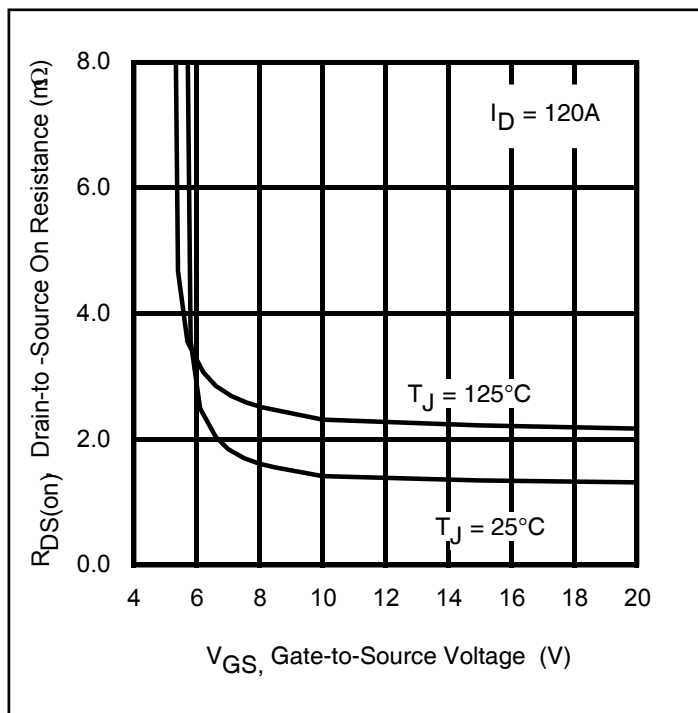

Figure 1 Typical On-Resistance vs. Gate Voltage

Figure 2 Typical On-Resistance vs. Drain Current

Table of Contents

Applications1

Ordering Table1

Table of Contents2

1 Parameters3

2 Maximum ratings, Thermal, and Avalanche characteristics4

3 Electrical characteristics5

4 Electrical characteristic diagrams6

Package Information14

Qualification Information16

Revision History17

1 Parameters

Table1 Key performance parameters

Parameter	Values	Units
V_{DS}	60	V
$R_{DS(on) max}$	1.5	m Ω
$I_D @ T_C$	345 	A
$I_D @ T_A$	36	A

2 Maximum ratings and thermal characteristics

Table 2 Maximum ratings (at $T_J=25^\circ\text{C}$, unless otherwise specified)

Parameter	Symbol	Conditions	Values	Unit
Continuous Drain Current (Silicon Limited) ④	I_D	$T_C = 25^\circ\text{C}, V_{GS} @ 10\text{V}$	345 ⑦	A
Continuous Drain Current (Silicon Limited) ④	I_D	$T_C = 100^\circ\text{C}, V_{GS} @ 10\text{V}$	243	
Continuous Drain Current (Silicon Limited) ①	I_D	$T_A = 25^\circ\text{C}, V_{GS} @ 10\text{V}$	36	
Continuous Drain Current (Package Limited) ④	I_D	$T_C = 25^\circ\text{C}, V_{GS} @ 10\text{V}$	375 ①	
Pulsed Drain Current ②	I_{DM}	$T_C = 25^\circ\text{C}$	1380	W
Maximum Power Dissipation	P_D	$T_C = 25^\circ\text{C}$	341	
Maximum Power Dissipation	P_D	$T_A = 25^\circ\text{C}$	3.8	W/ $^\circ\text{C}$
Linear Derating Factor	-	-	0.025	V
Gate-to-Source Voltage	V_{GS}	-	± 20	$^\circ\text{C}$
Operating Junction	T_J	-	-55 to +175	
Storage Temperature Range	T_{STG}	-		

Table 3 Thermal characteristics

Parameter	Symbol	Conditions	Min.	Typ.	Max.	Unit
Junction-to-Ambient ①	$R_{\theta JA}$	-	-	-	40	$^\circ\text{C}/\text{W}$
Junction-to-Ambient ③	$R_{\theta JA}$	-	-	12.5	-	
Junction-to-Ambient ②	$R_{\theta JA}$	-	-	20	-	
Junction-to-Case ④ ⑥	$R_{\theta JC}$	-	-	-	0.44	
Junction-to-PCB Mounted	$R_{\theta JA-PCB}$	-	-	-	0.5	

Table 4 Avalanche characteristics

Parameter	Symbol	Values	Unit
Single Pulse Avalanche Energy (Thermally Limited) ③	E_{AS}	315	mJ
Single Pulse Avalanche Energy (Tested) ③	E_{AS}	714	
Avalanche Current ②	I_{AR}	See Fig.15,16, 19a, 19b	A
Repetitive Avalanche Energy ②	E_{AR}		mJ

Notes:

- ① Package limit current based on source connection technology
- ② Repetitive rating; pulse width limited by max. junction temperature.
- ③ Limited by T_{Jmax} , starting $T_J = 25^\circ\text{C}$, $L = 0.044\text{mH}$, $R_G = 50\Omega$, $I_{AS} = 120\text{A}$, $V_{GS} = 10\text{V}$.
- ④ Pulse width $\leq 400\mu\text{s}$; duty cycle $\leq 2\%$.
- ⑤ C_{oss} eff. (TR) is a fixed capacitance that gives the same charging time as C_{oss} while V_{DS} is rising from 0 to 80% V_{DSS} .
- ⑥ R_θ is measured at T_J approximately 90°C .
- ⑦ Silicon limit current based on maximum allowable junction temperature T_{Jmax} .

3 Electrical characteristics

Table 5 Static characteristics

Parameter	Symbol	Conditions	Values			Unit
			Min.	Typ.	Max.	
Drain-to-Source Breakdown Voltage	$V_{(BR)DSS}$	$V_{GS} = 0V, I_D = 250\mu A$	60	-	-	V
Breakdown Voltage Temp. Coefficient	$\Delta V_{(BR)DSS}/\Delta T_J$	Reference to 25°C, $I_D = 3.0mA$	-	56	-	mV/°C
Static Drain-to-Source On-Resistance	$R_{DS(on)}$	$V_{GS} = 10V, I_D = 120A$	-	1.1	1.5	mΩ
Gate Threshold Voltage	$V_{GS(th)}$	$V_{DS} = V_{GS}, I_D = 250\mu A$	2.0	-	4.0	V
Gate Threshold Voltage Coefficient	$\Delta V_{GS(th)}/\Delta T_J$		-	8.8	-	mV/°C
Drain-to-Source Leakage Current	I_{DSS}	$V_{DS} = 60V, V_{GS} = 0V$	-	-	20	μA
		$V_{DS} = 60V, V_{GS} = 0V, T_J = 125^\circ C$	-	-	250	
Gate-to-Source Forward Leakage	I_{GSS}	$V_{GS} = 20V$	-	-	100	nA
	I_{GSS}	$V_{GS} = -20V$	-	-	100	
Gate Resistance	R_G	-	-	1.5	-	Ω

Table 6 Dynamic characteristics

Parameter	Symbol	Conditions	Values			Unit
			Min.	Typ.	Max.	
Forward Trans conductance	gfs	$V_{DS} = 10V, I_D = 120A$	185	-	-	S
Total Gate Charge	Q_g	$I_D = 120A$ $V_{DS} = 30V$ $V_{GS} = 10V$ ④	-	183	275	nC
Gate-to-Source Charge	Q_{gs1}		-	39	-	
Gate-to-Source Charge	Q_{gs2}		-	19	-	
Gate-to-Drain ("Miller) Charge	Q_{gd}		-	46	-	
Gate Charge Overdrive	Q_{godr}		-	79	-	
Switch Charge ($Q_{gs2} + Q_{gd}$)	Q_{sw}		-	65	-	
Output Charge	Q_{oss}	$V_{DS} = 48V, V_{GS} = 0V$	-	119	-	nC
Turn-On Delay Time	$t_{d(on)}$	$V_{DD} = 30V$	-	29	-	ns
Rise Time	t_r	$I_D = 120A$	-	149	-	
Turn-Off Delay Time	$t_{d(off)}$	$R_G = 1.8\Omega$	-	72	-	
Fall Time	t_f	$V_{GS} = 10V$ ④	-	88	-	
Input Capacitance	C_{iss}	$V_{GS} = 0V$	-	10655	-	pF
Output Capacitance	C_{oss}	$V_{DS} = 25V$	-	1627	-	
Reverse Transfer Capacitance	C_{rss}	$f = 1.0MHz$	-	680	-	
Effective Output Capacitance	$C_{oss\ eff.}$	$V_{GS} = 0V, V_{DS} = 0V\ to\ 48V$ ⑤	-	1959	-	

Table 7 Reverse Diode

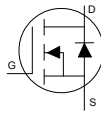
Parameter	Symbol	Conditions	Values			Unit
			Min.	Typ.	Max.	
Continuous Source Current (Body Diode)	I_S	MOSFET symbol showing the integral reverse p-n junction diode. 	-	-	345	A
Pulsed Source Current (Body Diode) ②	I_{SM}		-	-	1380	
Diode Forward Voltage	V_{SD}	$T_J = 25^\circ C, I_S = 120A, V_{GS} = 0V$ ④	-	-	1.3	V
Reverse Recovery Time	t_{rr}	$T_J = 25^\circ C, I_F = 120A,$	-	42	-	ns
Reverse Recovery Charge	Q_{rr}	$V_{DD} = 30V, di/dt = 100A/\mu s$ ④	-	54	-	nC

4 Electrical characteristic diagrams

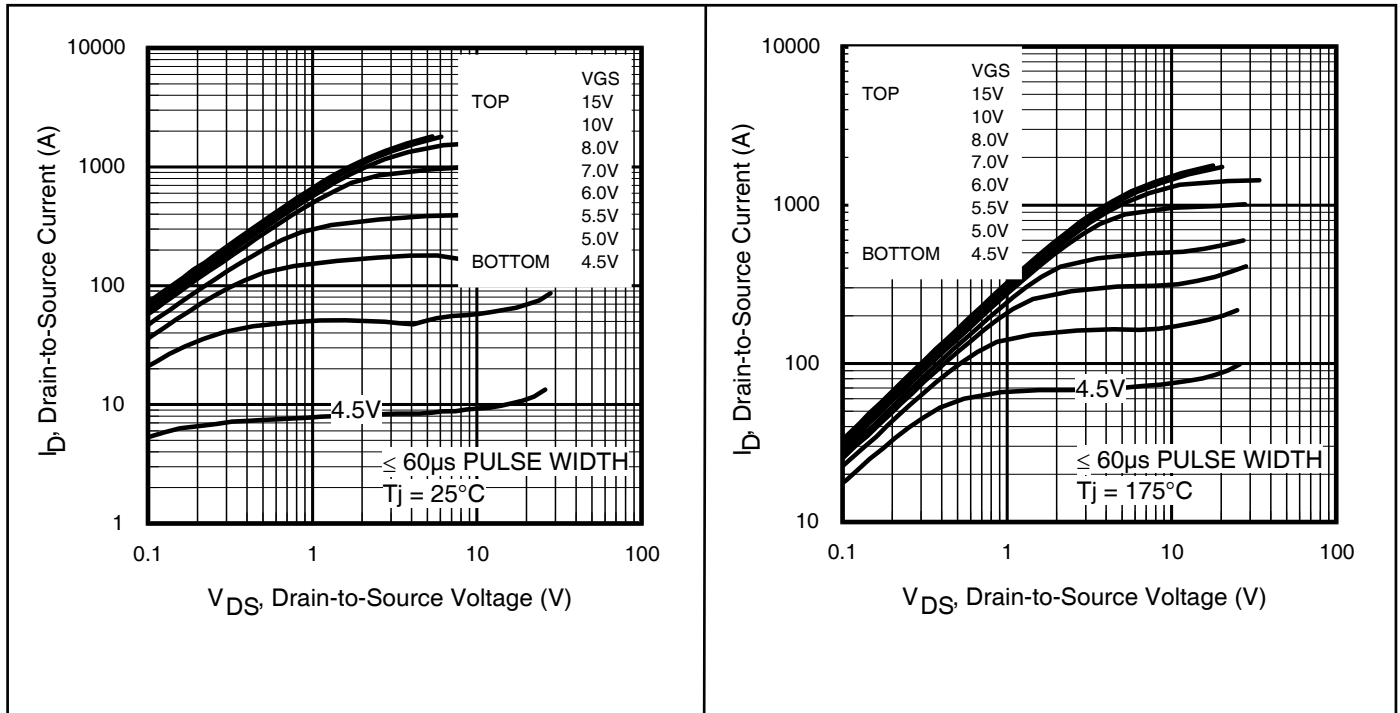

Figure 3 Typical Output Characteristics

Figure 4 Typical Output Characteristics

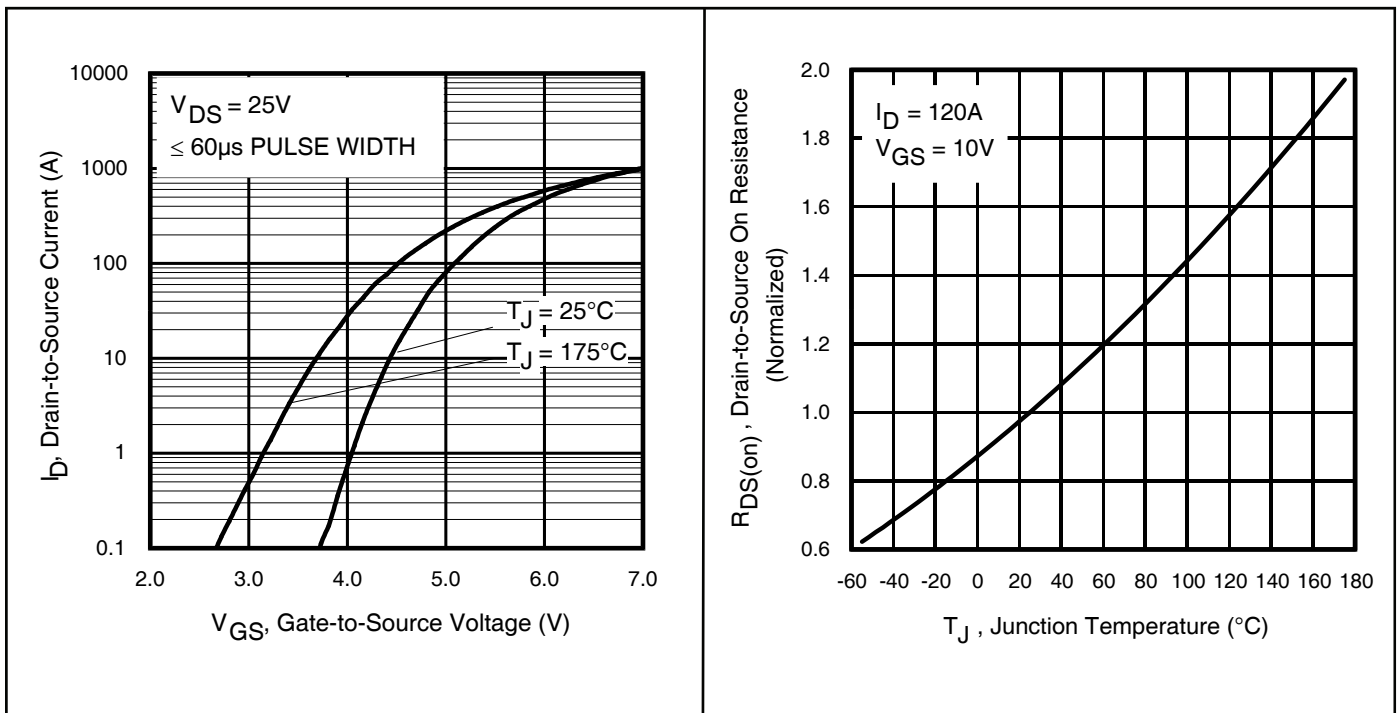

Figure 5 Typical Transfer Characteristics

Figure 6 Normalized On-Resistance vs. Temperature

Electrical characteristic diagrams

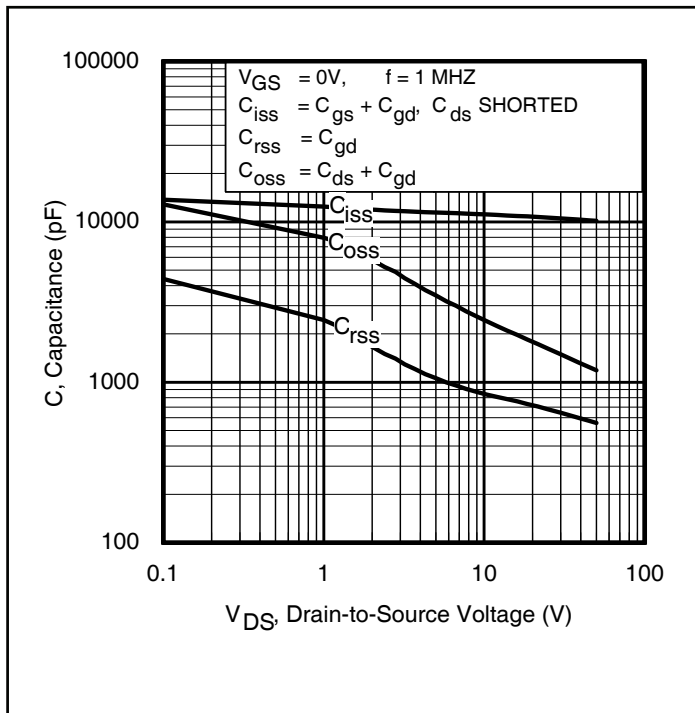

Figure 7 Typical Capacitance vs. Drain-to-Source Voltage

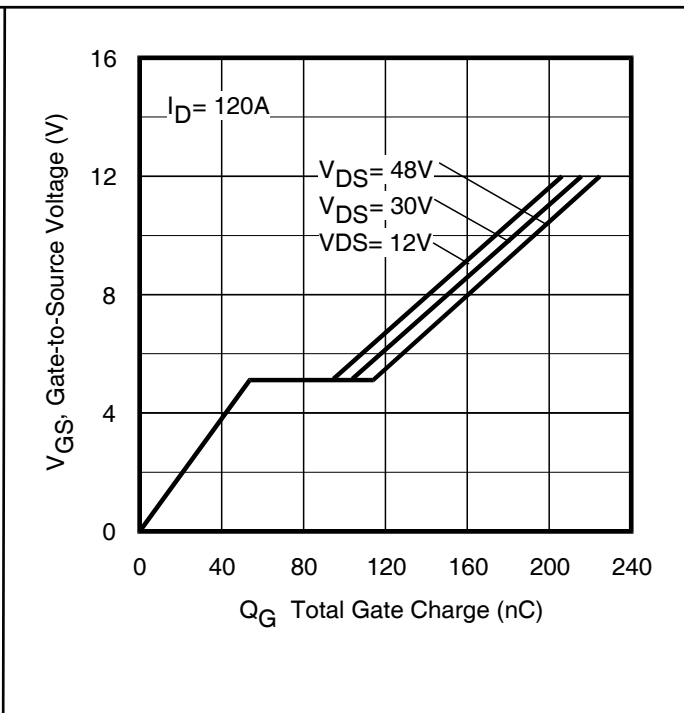

Figure 8 Typical Gate Charge vs. Gate-to-Source Voltage

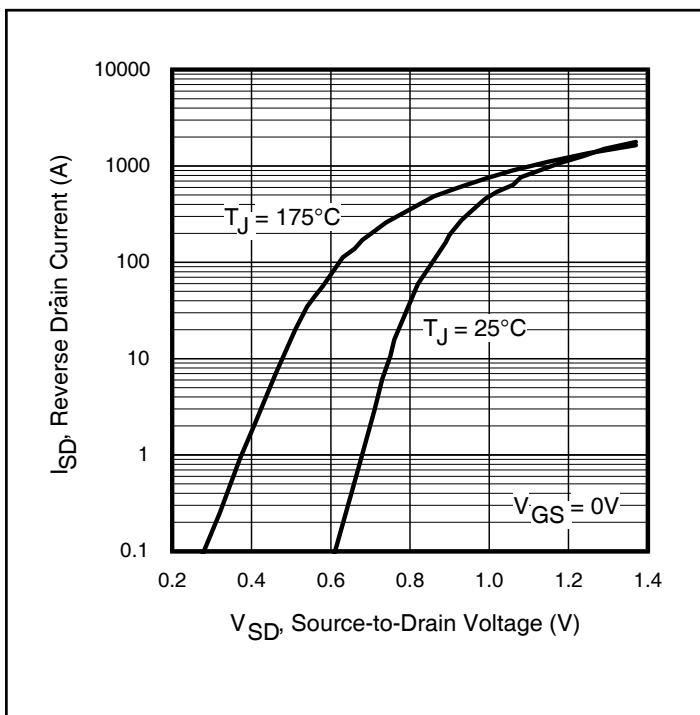

Figure 9 Typical Source-Drain Diode Forward Voltage

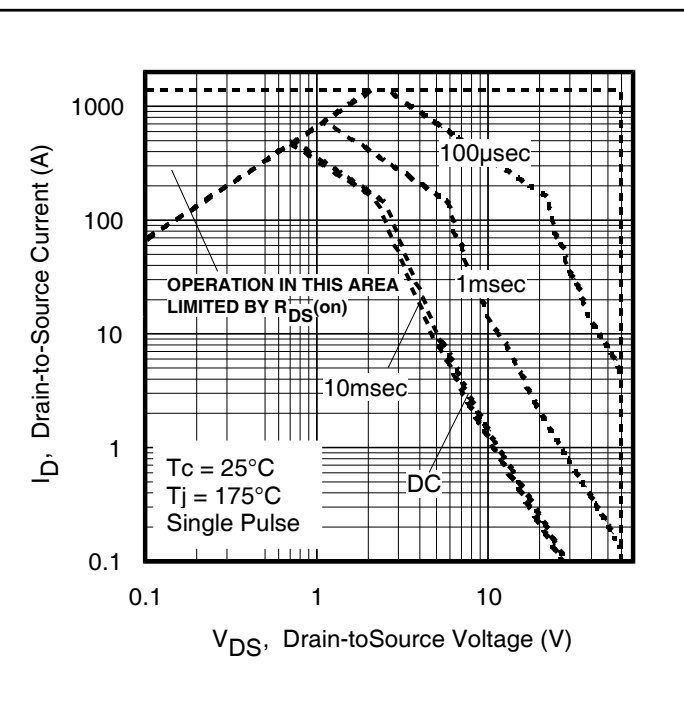

Figure 10 Maximum Safe Operating Area

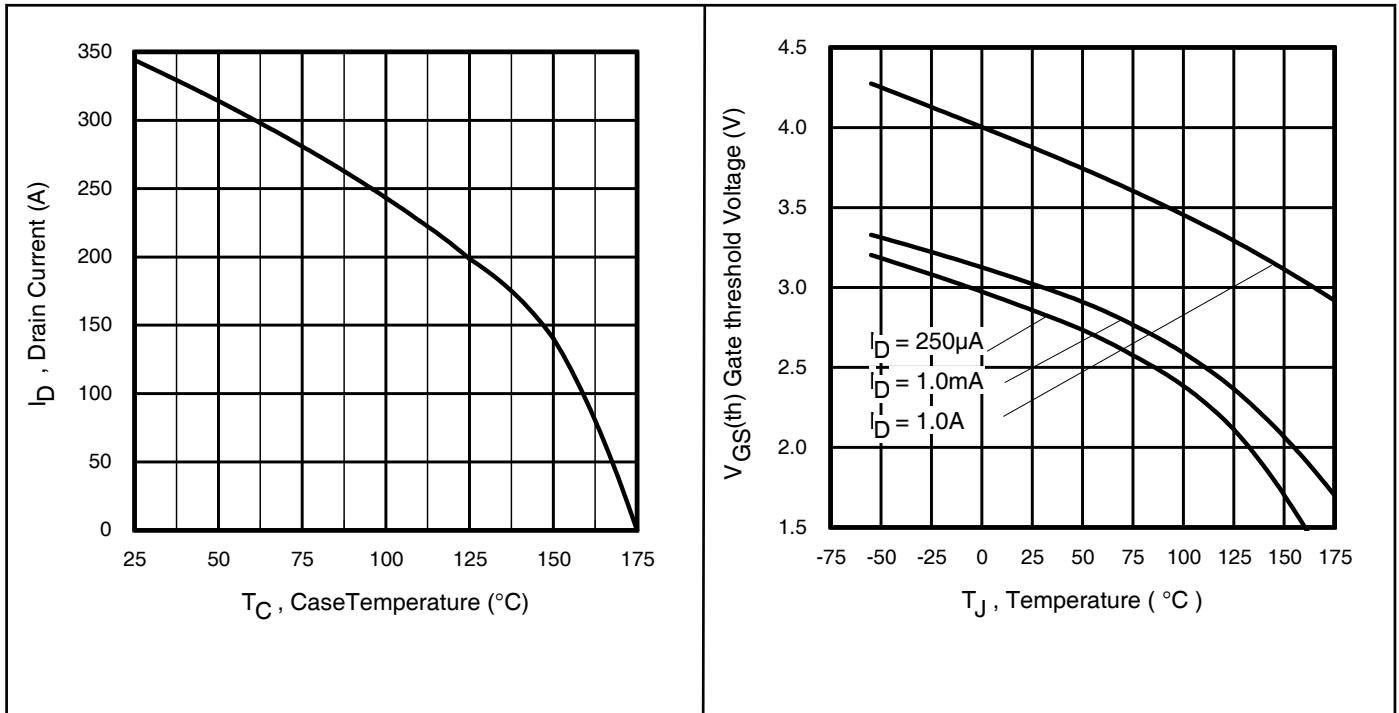

Figure 11 Maximum Drain Current vs. Case Temperature

Figure 12 Typical Threshold Voltage vs. Junction Temperature

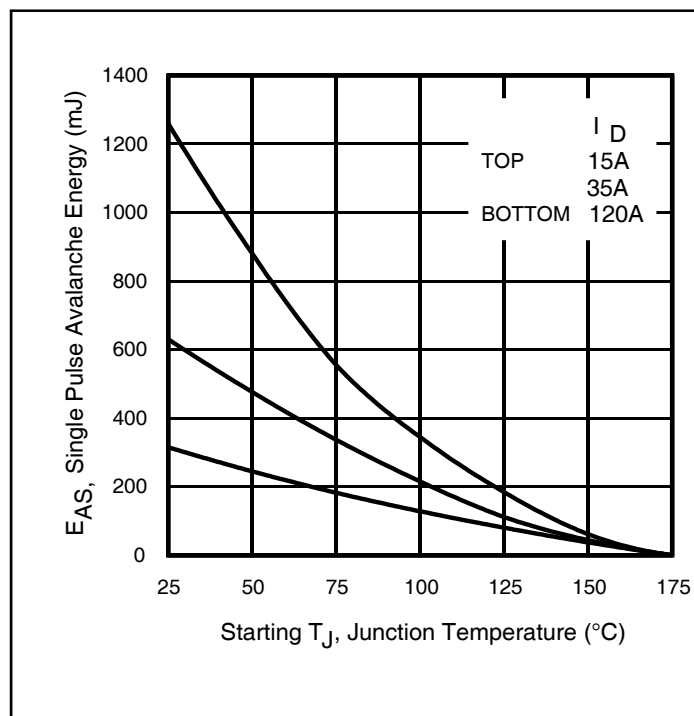

Figure 13 Maximum Avalanche Energy vs. Temperature

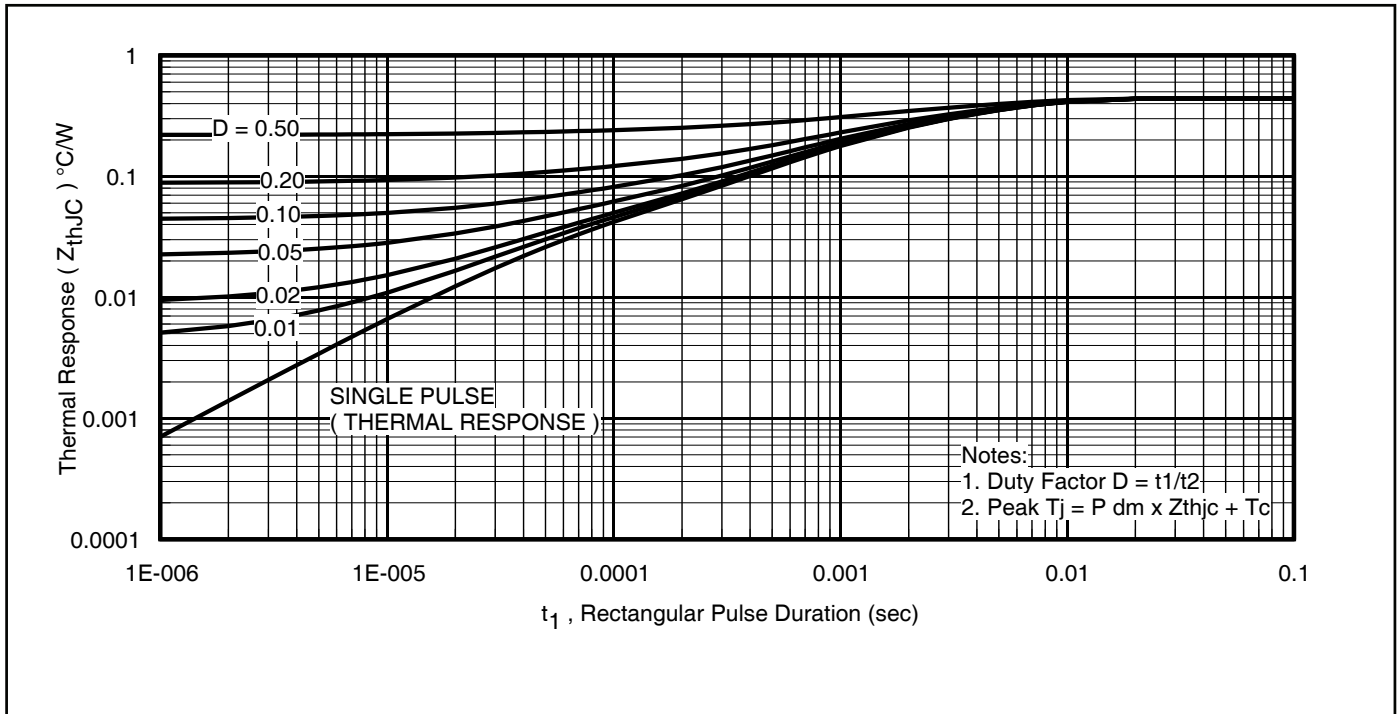

Figure 14 Maximum Effective Transient Thermal Impedance, Junction-to-Case

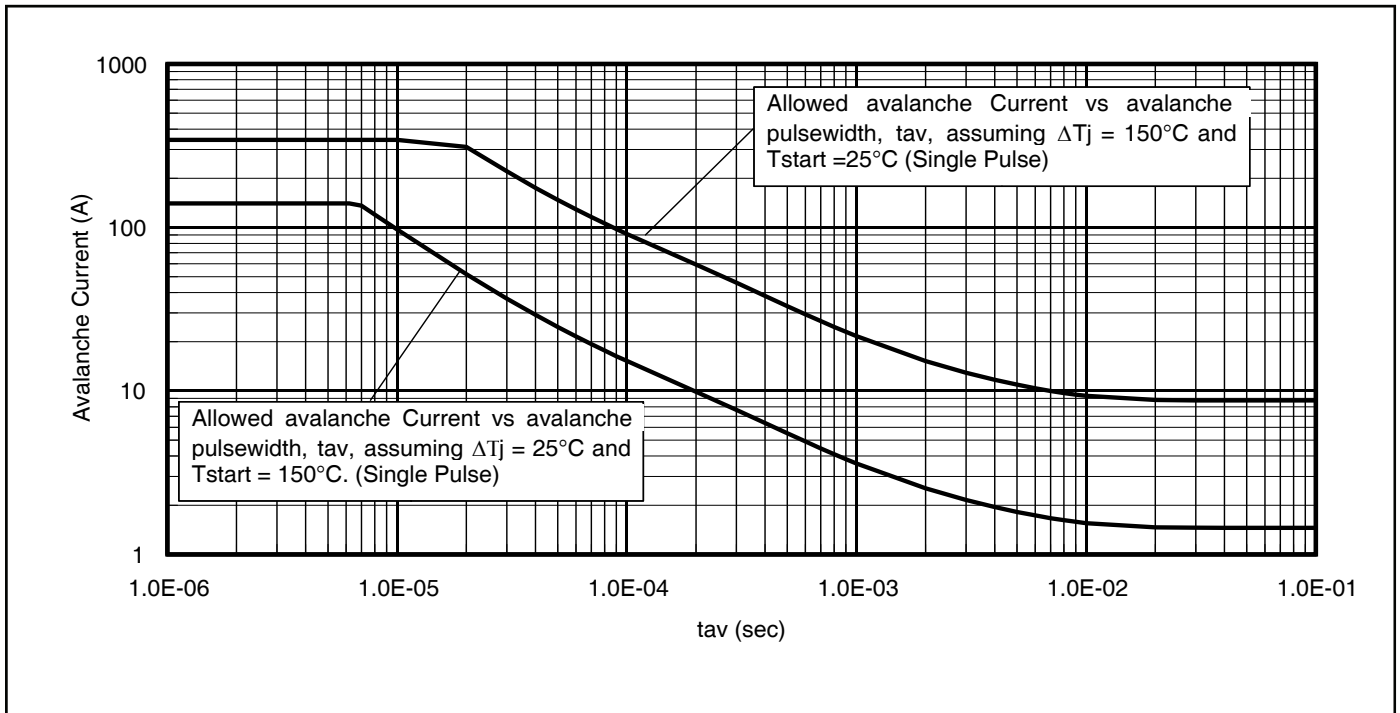
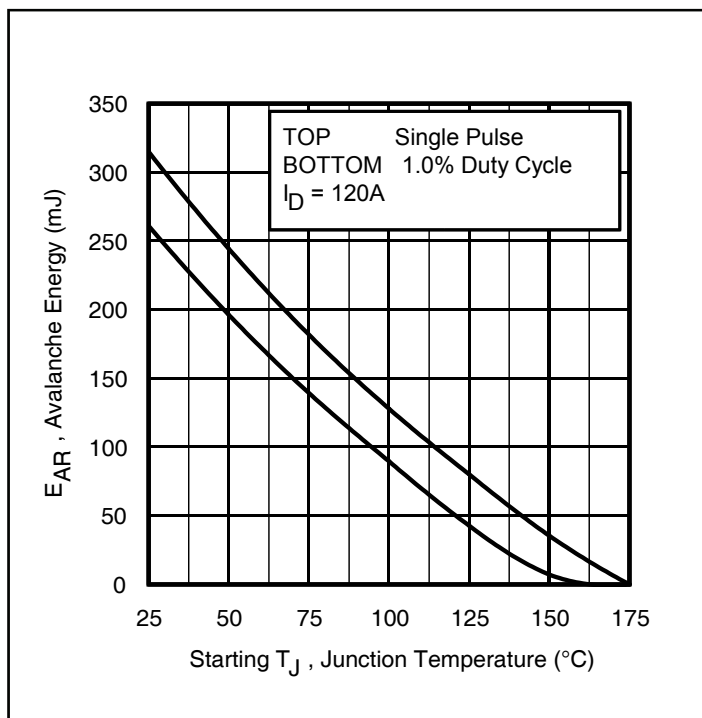

Figure 15 Typical Avalanche Current vs. Pulse Width



**Notes on Repetitive Avalanche Curves , Figures 15, 16:
(For further info, see AN-1005 at www.infineon.com)**

1. Avalanche failures assumption:
Purely a thermal phenomenon and failure occurs at a temperature far in excess of T_{jmax} . This is validated for every part type.
2. Safe operation in Avalanche is allowed as long as T_{jmax} is not exceeded.
3. Equation below based on circuit and waveforms shown in Figures 19a, 19b.
4. $P_{D(ave)}$ = Average power dissipation per single avalanche pulse.
5. BV = Rated breakdown voltage (1.3 factor accounts for voltage increase during avalanche).
6. I_{av} = Allowable avalanche current.
7. DT = Allowable rise in junction temperature, not to exceed T_{jmax} (assumed as 25°C in Figure 14, 15).
 t_{av} = Average time in avalanche.
 D = Duty cycle in avalanche = $t_{av} \cdot f$
 $Z_{thJC}(D, t_{av})$ = Transient thermal resistance, see Figures 14)
 $P_{D(ave)} = 1/2 (1.3 \cdot BV \cdot I_{av}) = \Delta T / Z_{thJC}$
 $I_{av} = 2\Delta T / [1.3 \cdot BV \cdot Z_{th}]$
 $E_{AS(AR)} = P_{D(ave)} \cdot t_{av}$

Figure 16 Maximum Avalanche Energy vs. Temperature

Notes:

- ① Used double sided cooling , mounting pad with large heatsink
- ② Mounted on minimum footprint full size board with metalized back and with small clip heatsink.
- ③ TC measured with thermocouple mounted to top (Drain) of part.

① Surface mounted on 1 in. square Cu board (still air).

② Mounted to a PCB with small clip heatsink (still air).

③ Mounted on minimum footprint full size board with metalized back and with small clip heatsink (still air)

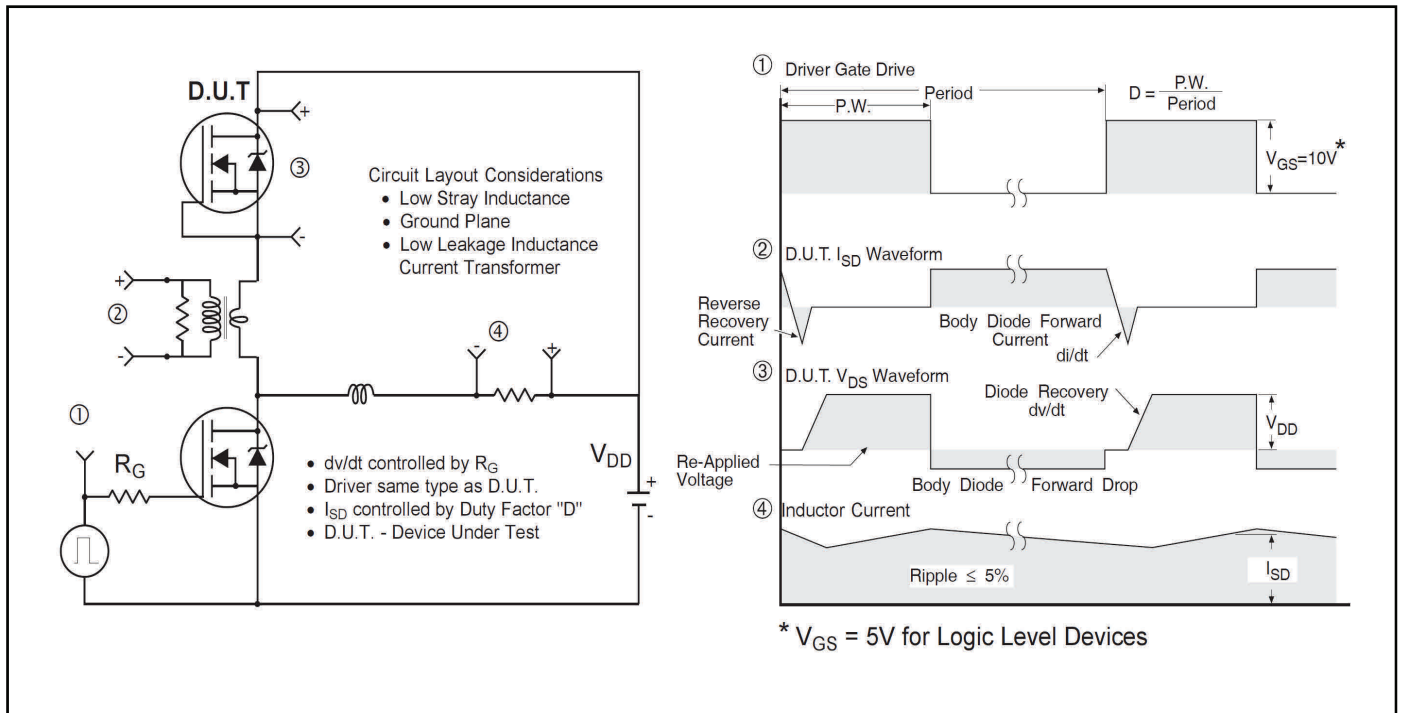

Figure 17 Peak Diode Recovery dv/dt Test Circuit for N-Channel HEXFET™ Power MOSFETs

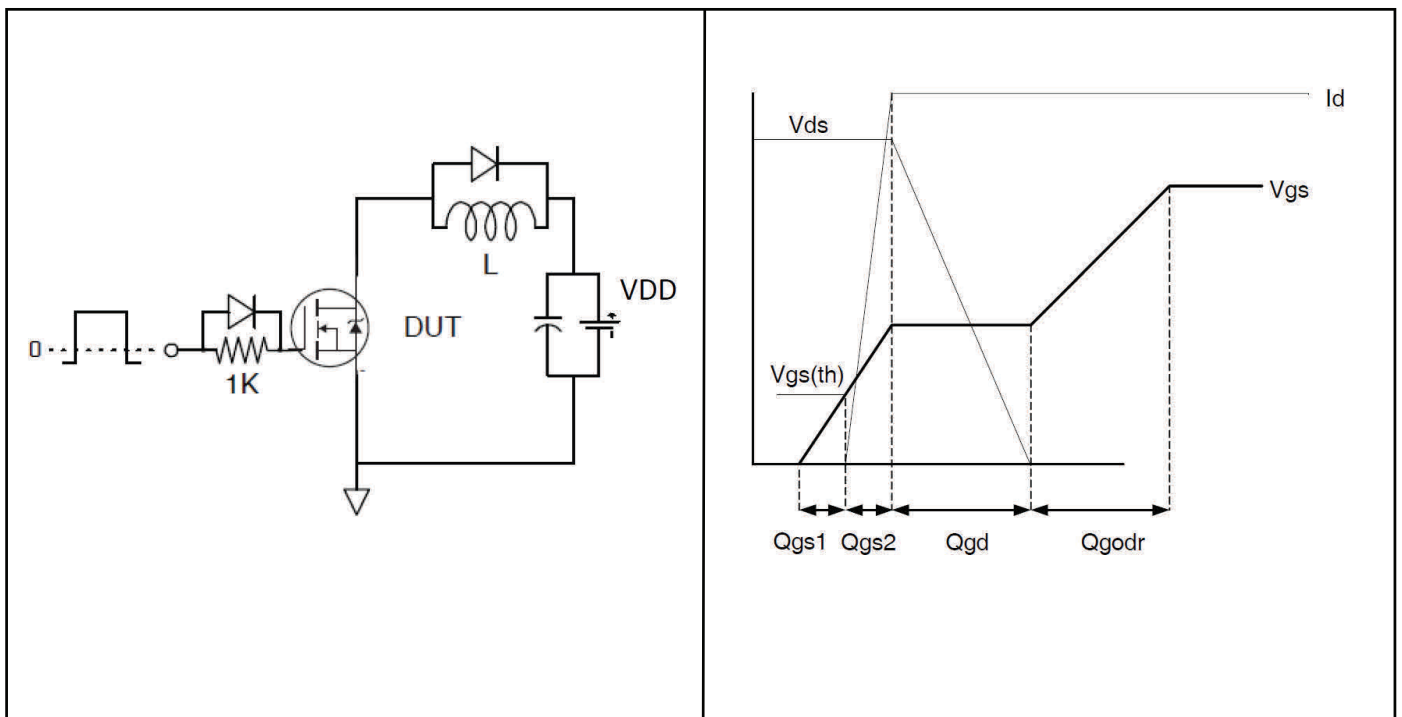

Figure 18a Gate Charge Test Circuit

Figure 18b Gate Charge Waveform

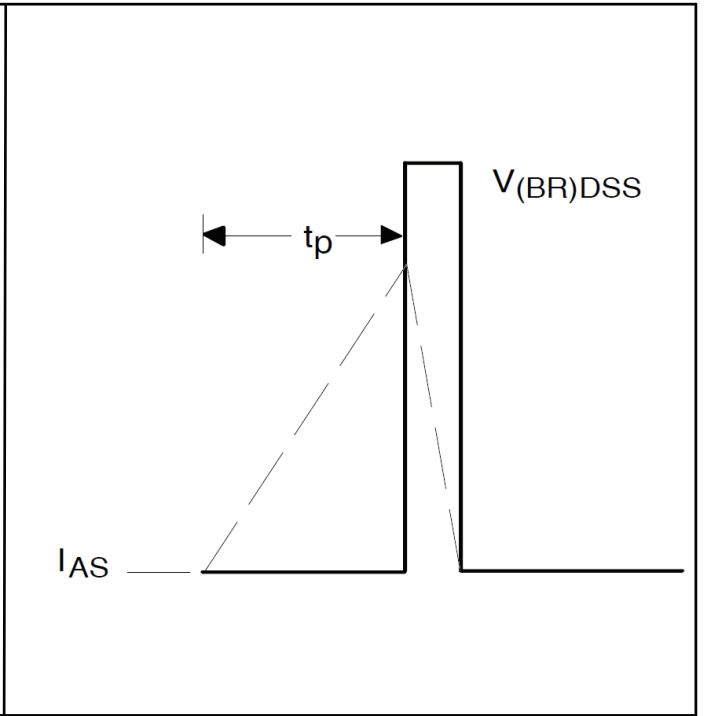
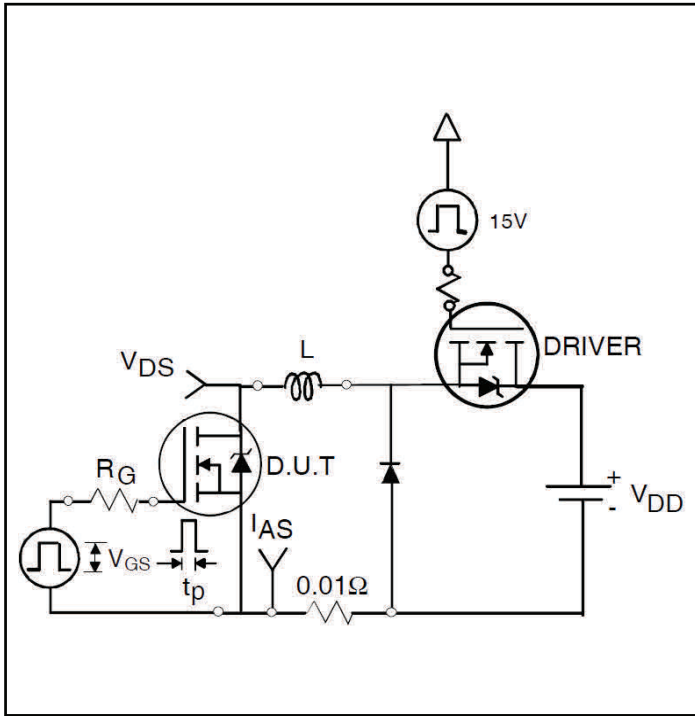

Figure 19a Unclamped Inductive Test Circuit

Figure 19b Unclamped Inductive Waveforms

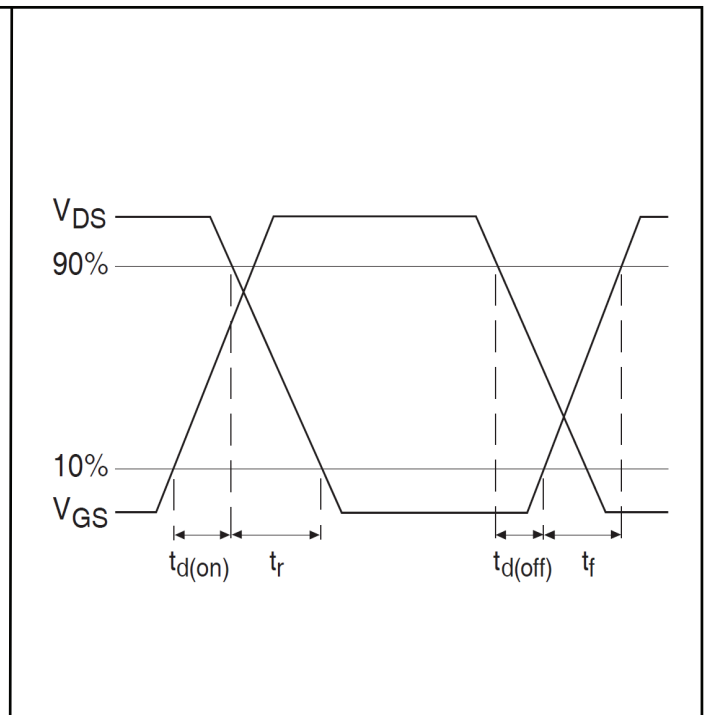
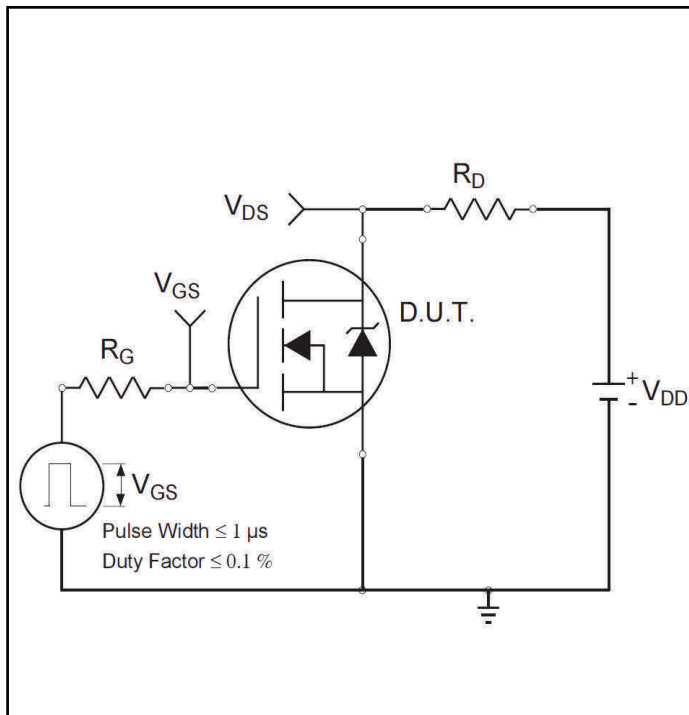

Figure 20a Switching Time Test Circuit

Figure 20b Switching Time Waveforms

5 Package Information

DirectFET™ Board Footprint, L8 Outline (Large Size Can, 8-Source Pads)

Please see DirectFET™ application note [AN-1035](#) for all details regarding the assembly of DirectFET™. This includes all recommendations for stencil and substrate designs.

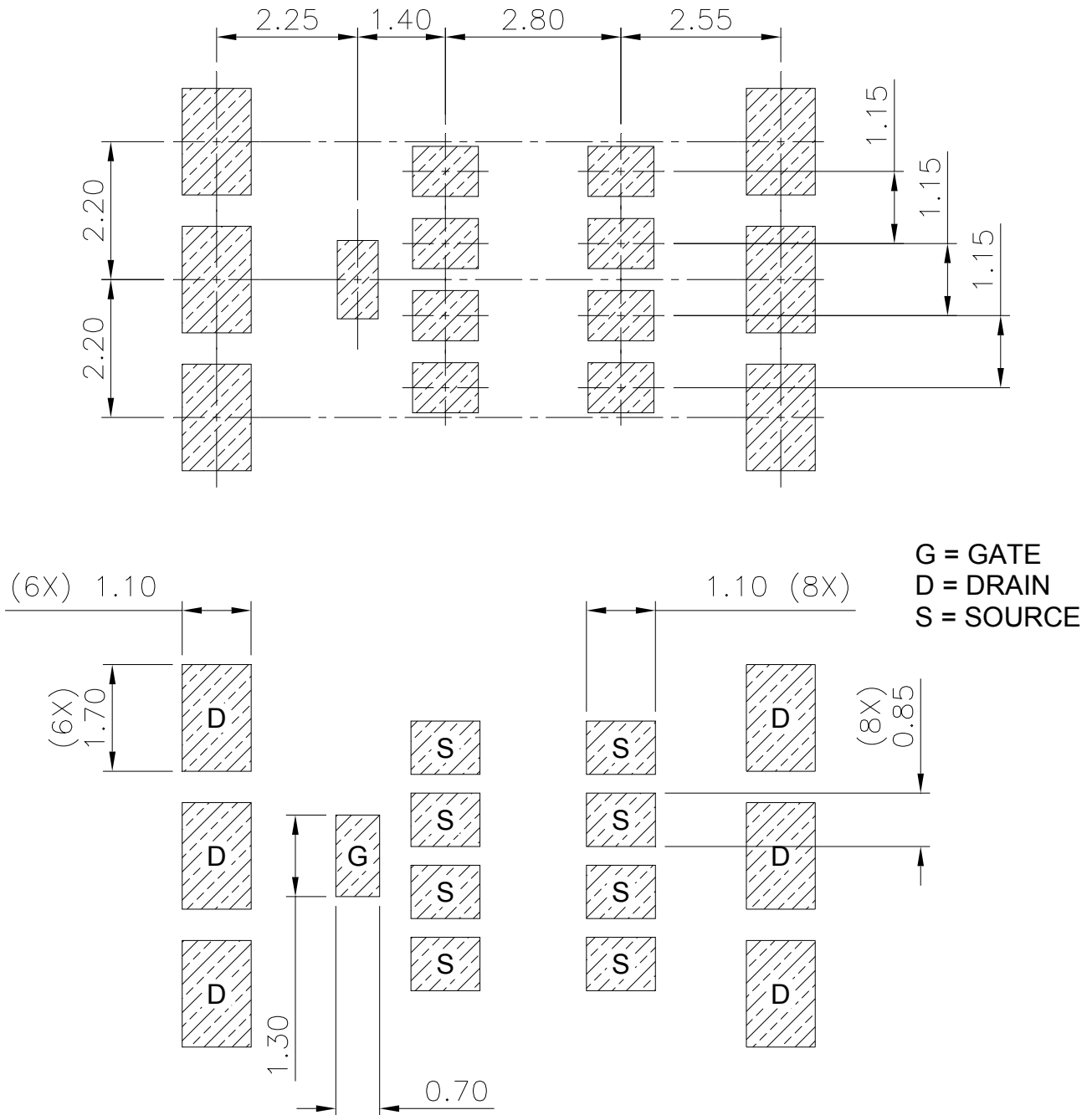

IRF7749L1TRPbF

Package Information

DirectFET™ Outline Dimension, L8 Outline
(Large Size Can, 8-Source Pads)

Please see DirectFET™ application note [AN-1035](#) for all details regarding the assembly of DirectFET™. This includes all recommendations for stencil and substrate designs.

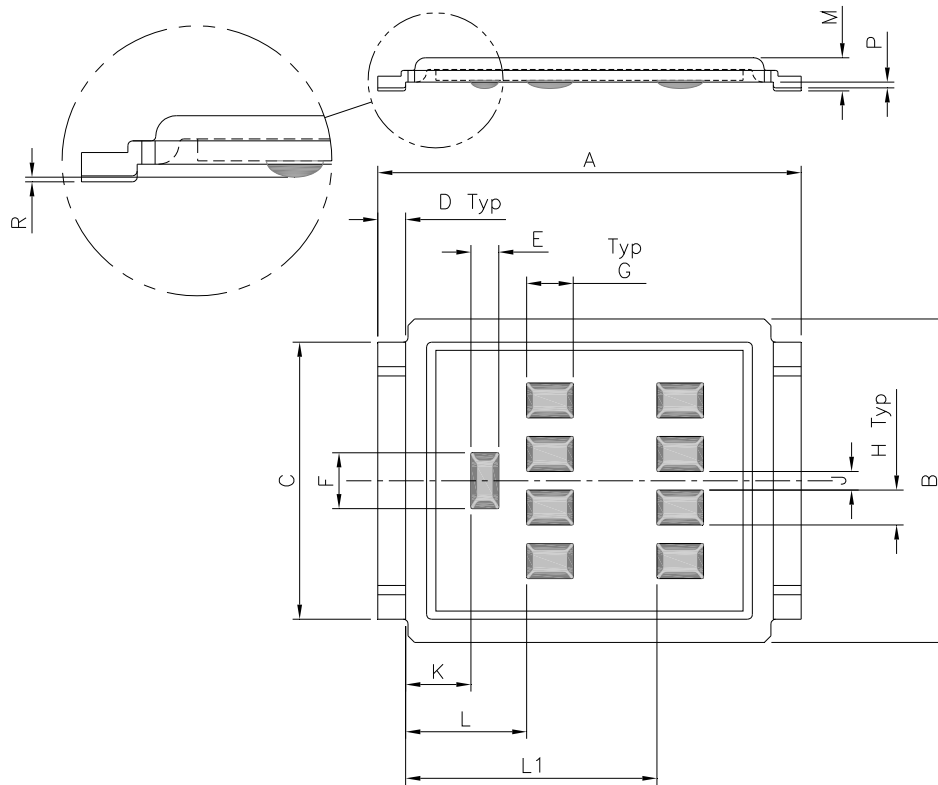

CODE	METRIC		IMPERIAL	
	MIN	MAX	MIN	MAX
A	9.05	9.15	0.356	0.360
B	6.85	7.10	0.270	0.280
C	5.90	6.00	0.232	0.236
D	0.55	0.65	0.022	0.026
E	0.58	0.62	0.023	0.024
F	1.18	1.22	0.046	0.048
G	0.98	1.02	0.039	0.040
H	0.73	0.77	0.029	0.030
J	0.38	0.42	0.015	0.017
K	1.35	1.45	0.053	0.057
L	2.55	2.65	0.100	0.104
L1	5.35	5.45	0.211	0.215
M	0.68	0.74	0.027	0.029
P	0.09	0.17	0.003	0.007
R	0.02	0.08	0.001	0.003

DirectFET™ Part Marking

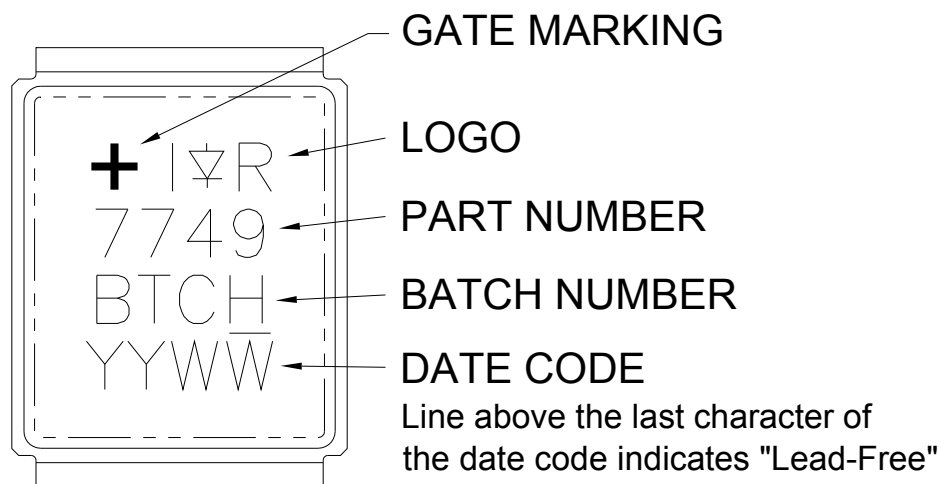

Tape & Reel Information

DirectFET™ Tape & Reel Dimension (Showing component orientation).

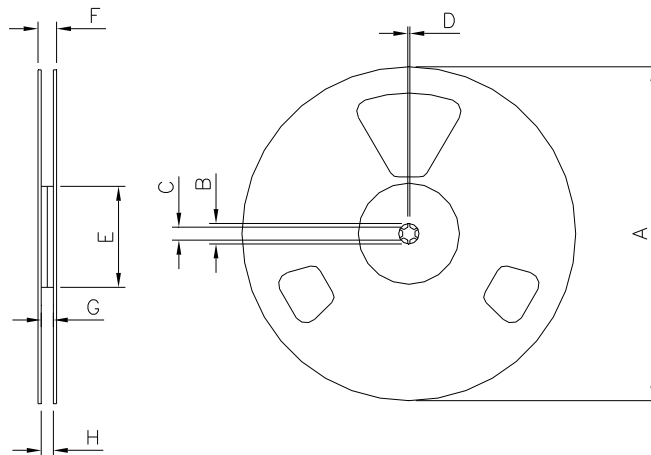

NOTE: Controlling dimensions in mm
Std reel quantity is 4000 parts. (ordered as IRF7749L1TRPbF).

REEL DIMENSIONS				
STANDARD OPTION (QTY 4000)				
	METRIC		IMPERIAL	
CODE	MIN	MAX	MIN	MAX
A	330.00	N.C	12.992	N.C
B	20.20	N.C	0.795	N.C
C	12.80	13.20	0.504	0.520
D	1.50	N.C	0.059	N.C
E	99.00	100.00	3.900	3.940
F	N.C	22.40	N.C	0.880
G	16.40	18.40	0.650	0.720
H	15.90	19.40	0.630	0.760

LOADED TAPE FEED DIRECTION

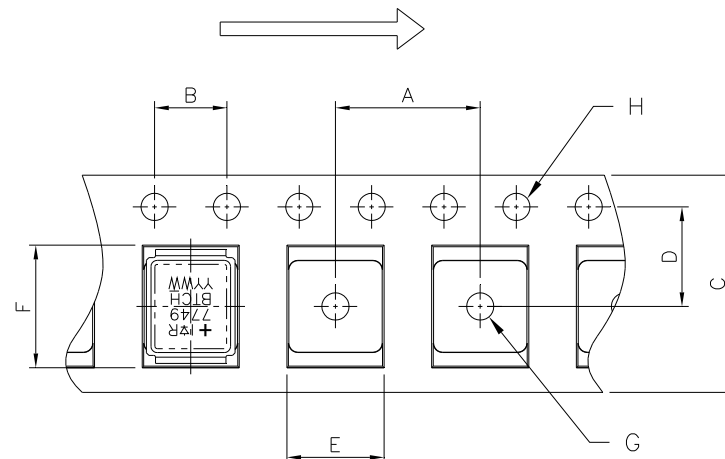

NOTE: CONTROLLING DIMENSIONS IN MM

DIMENSIONS				
	METRIC		IMPERIAL	
CODE	MIN	MAX	MIN	MAX
A	11.90	12.10	4.69	0.476
B	3.90	4.10	0.154	0.161
C	15.90	16.30	0.623	0.642
D	7.40	7.60	0.291	0.299
E	7.20	7.40	0.283	0.291
F	9.90	10.10	0.390	0.398
G	1.50	N.C	0.059	N.C
H	1.50	1.60	0.059	0.063

6 Qualification Information

Qualification Information

Qualification Level	Industrial (per JEDEC JESD47F) †	
Moisture Sensitivity Level	DirectFET™ Large Can	MSL1 (per JEDEC J-STD-020D)†
RoHS Compliant	Yes	

† Applicable version of JEDEC standard at the time of product release.

Revision History

Major changes since the last revision

Page or Reference	Revision	Date	Description of changes
All pages	2.0	2013-01-07	• First release Final data sheet.
All pages	2.1	2013-02-13	• TR1 option removed and Tape & Reel Info updated accordingly. • Hyperlinks added throw-out the document
All pages	2.2	2019-02-20	• Update to R-Theta.

Trademarks of Infineon Technologies AG

µHVIC™, µIPM™, µPFC™, AU-ConvertIR™, AURIX™, C166™, CanPAK™, CIPOST™, CIPURSE™, CoolDP™, CoolGaN™, COOLiR™, CoolMOS™, CoolSET™, CoolSiC™, DAVE™, DI-POL™, DirectFET™, DrBlade™, EasyPIM™, EconoBRIDGE™, EconoDUAL™, EconoPACK™, EconoPIM™, EiceDRIVER™, eupec™, FCOS™, GaNpowIR™, HEXFET™, HITFET™, HybridPACK™, iMOTION™, IRAM™, ISOFACE™, IsoPACK™, LEDrivIR™, LITIX™, MIPAQ™, ModSTACK™, my-d™, NovalithIC™, OPTIGA™, OptiMOS™, ORIGA™, PowIRaudio™, PowIRstage™, PrimePACK™, PrimeSTACK™, PROFET™, PRO-SIL™, RASIC™, REAL3™, SmartLEWIS™, SOLID FLASH™, SPOC™, StrongIRFET™, SupIRBuck™, TEMPFET™, TRENCHSTOP™, TriCore™, UHVIC™, XHP™, XMC™

Trademarks updated November 2015

Other Trademarks

All referenced product or service names and trademarks are the property of their respective owners.

IMPORTANT NOTICE

The information given in this document shall in no event be regarded as a guarantee of conditions or characteristics ("Beschaffenheitsgarantie").

With respect to any examples, hints or any typical values stated herein and/or any information regarding the application of the product, Infineon Technologies hereby disclaims any and all warranties and liabilities of any kind, including without limitation warranties of non-infringement of intellectual property rights of any third party.

In addition, any information given in this document is subject to customer's compliance with its obligations stated in this document and any applicable legal requirements, norms and standards concerning customer's products and any use of the product of Infineon Technologies in customer's applications.

The data contained in this document is exclusively intended for technically trained staff. It is the responsibility of customer's technical departments to evaluate the suitability of the product for the intended application and the completeness of the product information given in this document with

For further information on the product, technology, delivery terms and conditions and prices please contact your nearest Infineon Technologies office (www.infineon.com).

WARNINGS

Due to technical requirements products may contain dangerous substances. For information on the types in question please contact your nearest Infineon Technologies office.

Except as otherwise explicitly approved by Infineon Technologies in a written document signed by authorized representatives of Infineon Technologies, Infineon Technologies' products may not be used in any applications where a failure of the product or any consequences of the use thereof can reasonably be expected to result in personal injury.

Edition 2015-05-06

**Published by
Infineon Technologies AG
81726 Munich, Germany**

**© 2016 Infineon Technologies AG.
All Rights Reserved.**

Do you have a question about this document?

Email: erratum@infineon.com

Document reference