



CERAMIC

High Pass Filter

HFCW-5500+

50Ω 6100 to 20000 MHz

THE BIG DEAL

- Good rejection, 45 dB typical
- Rugged, ceramic construction
- Tiny size, 0603 (0.063" X 0.032" X 0.024")
- Good power handling, 1.75W
- Temperature stable
- LTCC construction



Generic photo used for illustration purposes only

CASE STYLE: JC0603C

+RoHS Compliant

The +Suffix identifies RoHS Compliance. See our web site for RoHS Compliance methodologies and qualifications

APPLICATIONS

- Test and measurements
- Military applications
- Telecommunications and broadband wireless systems

PRODUCT OVERVIEW

HFCW-5500+ is a high pass filter with passband from 6100 MHz to 20000 MHz supporting a variety of applications. This model provides good insertion loss over a wide band due to strategically constructed layout. Housed in a tiny 0603 ceramic form factor with wraparound terminations, the filter is ideal for dense PCB layouts.

KEY FEATURES

Feature	Advantages
Ultra-wide stopband	This filter has a very wide passband from 6.1 GHz to 20 GHz.
LTCC Construction	Provides repeatable performance in a rugged, ceramic package well suited for tough environments such as high humidity and temperature extremes.
Small size, 0603 (0.063" X 0.032" X 0.024")	Saves space in dense circuit board layouts and minimizes the effects of parasitics.
Wrap-around terminations	Provides excellent solderability and easy visual inspection.

REV. OR
ECO-011416
HFCW-5500+
URJ
220118





CERAMIC

High Pass Filter

HFCW-5500+

ELECTRICAL SPECIFICATIONS^{1,2} AT 25°C

Parameter		F#	Frequency (MHz)	Min.	Typ.	Max.	Units
Stopband	Rejection Loss	DC-F1	DC - 3300	39	44	—	dB
		F1-F2	3300 - 4400	25	45	—	dB
	Freq. Cut-Off	F3*	5500	—	3	—	dB
Passband	Insertion Loss	F4-F5	6100 - 7400	—	2.6	—	dB
		F5-F6	7400 - 13500	—	0.9	1.5	dB
		F6-F7	13500 - 20000	—	1.4	—	dB
	Return Loss	F4-F5	6100 - 7400	—	10	—	dB
		F5-F6	7400 - 13500	—	15	—	dB
		F6-F7	13500 - 20000	—	11	—	dB

1 DC de-coupling capacitors are required in Applications where DC voltage and/or current is present at either input or output ports. Please contact Mini-Circuits for alternatives if DC pass from IN-OUT is required.

2 Measured on Mini-Circuits Characterization Test Board TB-HFCW-5500+

* Typically, a ±5% frequency deviation from the stated value may occur on a unit-to-unit basis.

MAXIMUM RATINGS

Parameter	Ratings
Operating temperature	-55°C to 125°C
Storage temperature	-55°C to 125°C
RF Power Input*	1.75W max.@25°C

*Passband rating, derate linearly to 0.5W at 125°C ambient
Permanent damage may occur if any of these limits are exceeded.

TYPICAL FREQUENCY RESPONSE

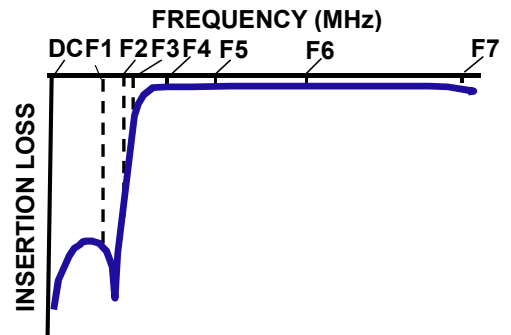

FUNCTIONAL SCHEMATIC

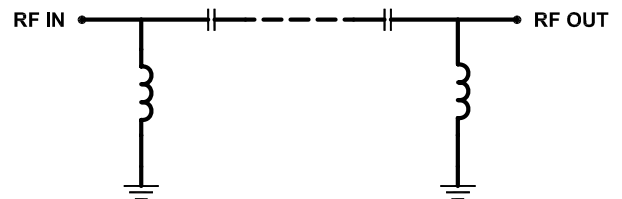



PAD CONNECTIONS

INPUT	1
OUTPUT	3
GROUND	2,4,5,6

PRODUCT MARKING: 5

DEMO BOARD MCL P/N: TB-HFCW-5500+ SUGGESTED PCB LAYOUT (PL-703)

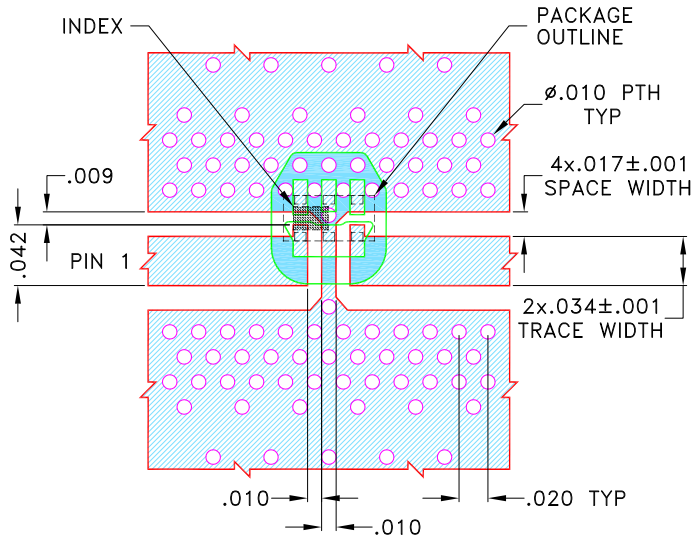

NOTES:

1. COPLANAR WAVEGUIDE PARAMETERS ARE SHOWN FOR ROGERS (R04350B) WITH DIELECTRIC THICKNESS .0200±.0015. COPPER: 1/2 Oz. EACH SIDE. FOR OTHER MATERIALS TRACE WIDTH AND GAP MAY NEED TO BE MODIFIED.
 2. BOTTOM SIDE OF THE PCB IS CONTINUOUS GROUND PLANE.
- DENOTES PCB COPPER PATTERN WITH SMOBC (SOLDER MASK OVER BARE COPPER)
- DENOTES PCB COPPER PATTERN FREE OF SOLDERMASK

OUTLINE DRAWING

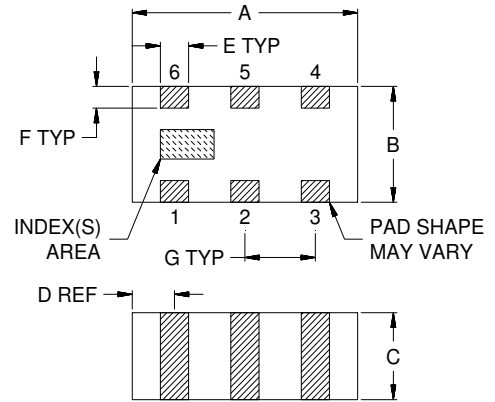

OUTLINE DIMENSIONS (Inches/mm)

A	B	C	D	E	F	G	Wt.
.063	.032	.024	.012	.008	.006	.020	grams
1.60	0.80	0.60	0.30	0.20	0.15	0.50	.005

Note: Please refer to case style drawing for details



CERAMIC

High Pass Filter

HFCW-5500+

TYPICAL PERFORMANCE DATA

Frequency (MHz)	Insertion Loss (dB)	Return Loss (dB)
10	77.99	0.07
100	66.53	0.08
2000	45.63	0.18
3300	54.32	0.20
4400	52.65	0.47
4800	31.73	0.75
5060	20.56	1.21
5500	5.02	6.41
5600	3.25	10.57
6100	1.23	20.30
7400	0.59	20.50
13500	0.34	18.57
14000	0.36	16.30
15000	0.42	14.11
20000	0.75	16.63

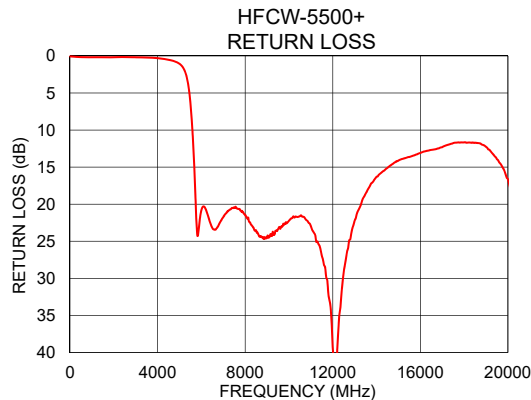
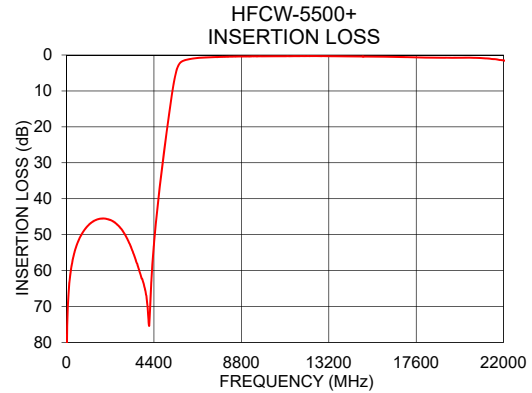
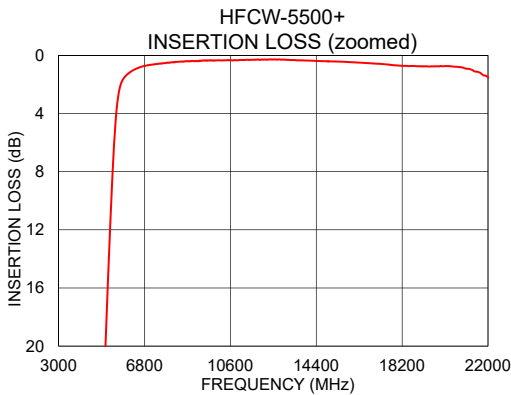

NOTES

- A. Performance and quality attributes and conditions not expressly stated in this specification document are intended to be excluded and do not form a part of this specification document.
- B. Electrical specifications and performance data contained in this specification document are based on Mini-Circuit's applicable established test performance criteria and measurement instructions.
- C. The parts covered by this specification document are subject to Mini-Circuits standard limited warranty and terms and conditions (collectively, "Standard Terms"); Purchasers of this part are entitled to the rights and benefits contained therein. For a full statement of the standard. Terms and the exclusive rights and remedies thereunder, please visit Mini-Circuits' website at www.minicircuits.com/MCLStore/terms.jsp

