

**SMBJ Series**



**Agency Approvals**

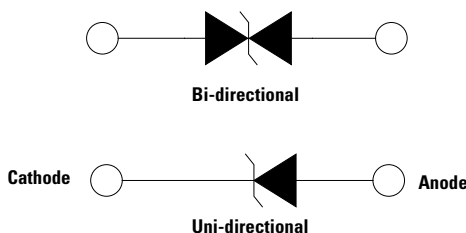
Agency	Agency File Number
	E230531

**Maximum Ratings and Thermal Characteristics  
(T<sub>A</sub>=25°C unless otherwise noted)**

Parameter	Symbol	Value	Unit
Peak Pulse Power Dissipation(Fig.2) by 10/1000us Test Waveform(Fig.4) (Note 1),(Note 2)-Single Die Parts	P <sub>PPM</sub>	600	W
Peak Pulse Power Dissipation(Fig.2) by 10/1000us Test Waveform(Fig.4) (Note 1), (Note 2)-Stacked Die Parts (Note 5)	P <sub>PPM</sub>	800	W
Power Dissipation on Infinite Heat Sink at T <sub>L</sub> =50°C	P <sub>D</sub>	5.0	W
Peak Forward Surge Current, 8.3ms Single Half Sine Wave (Note 3)	I <sub>FSM</sub>	100	A
Maximum Instantaneous Forward Voltage at 50A for Unidirectional Only (Note 4)	V <sub>F</sub>	3.5/5.0	V
Operating Temperature Range	T <sub>J</sub>	-65 to 150	°C
Storage Temperature Range	T <sub>STG</sub>	-65 to 175	°C
Typical Thermal Resistance Junction to Lead	R <sub>θJL</sub>	20	°C/W
Typical Thermal Resistance Junction to Ambient	R <sub>θJA</sub>	100	°C/W

- Notes:**
1. Non-repetitive current pulse, per Fig. 4 and derated above T<sub>J</sub> (initial) =25°C per Fig. 3.
  2. Mounted on copper pad area of 0.2x0.2" (5.0 x 5.0mm) to each terminal.
  3. Measured on 8.3ms single half sine wave or equivalent square wave for unidirectional device only, duty cycle=4 per minute maximum.
  4. V<sub>F</sub> < 3.5V for single die parts and V<sub>F</sub> < 5.0V for stacked-die parts.
  5. For stacked die component details, please refer to part numbers labeled by \* in Electrical Characteristics.

**Functional Diagram**



**Description**

The SMBJ series is designed specifically to protect sensitive electronic equipment from voltage transients induced by lightning and other transient voltage events.


**Features**

- Excellent clamping capability
- Low incremental surge resistance
- Typical I<sub>R</sub> less than 1µA when V<sub>BR</sub> min > 12V
- For surface mounted applications to optimize board space
- Low profile package
- Typical failure mode is short from over-specified voltage or current
- Whisker test is conducted based on JEDEC JESD201A per its table 4a and 4c
- IEC-61000-4-2 ESD 30kV(Air), 30kV (Contact)
- ESD protection of data lines in accordance with IEC 61000-4-2
- EFT protection of data lines in accordance with IEC 61000-4-4
- Built-in strain relief
- Fast response time: typically less than 1.0ps from 0V to VBR min
- 600W peak pulse power capability at 10/1000µs waveform, repetition rate (duty cycles):0.01%
- High temperature to reflow soldering guaranteed: 260°C/30sec
- V<sub>BR</sub> @ T<sub>J</sub> = V<sub>BR</sub> @ 25°C x (1 + α T x (T<sub>J</sub> - 25)) (α T: Temperature Coefficient, typical value is 0.1%)
- UL Recognized compound meeting flammability classification V-0
- Meet MSL level1, per J-STD-020, LF maximum peak of 260°C
- Matte tin lead-free plated
- Halogen free and RoHS compliant
- Pb-free E3 means 2nd level interconnect is Pb-free and the terminal finish material is tin(Sn) (IPC/ JEDEC J-STD-609A.01)
- UL Recognized to ANSI/UL 497B: Protectors for Data Communications and Fire-Alarm Circuits.

**Applications**

TVS components are ideal for the protection of I/O Interfaces, V<sub>CC</sub> bus and other vulnerable circuits used in Telecom, Computer, Industrial and Consumer electronic applications.

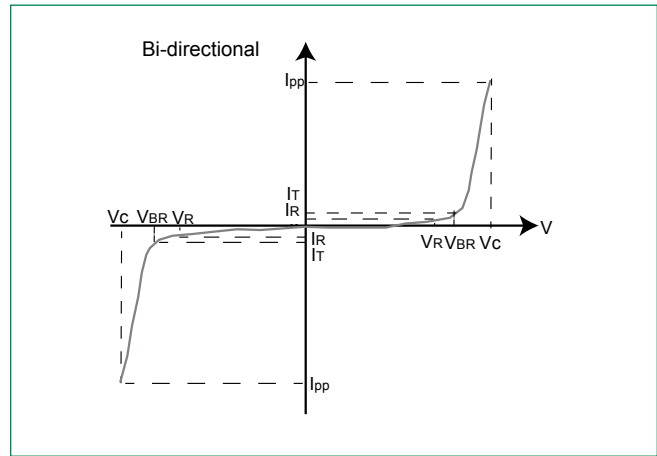
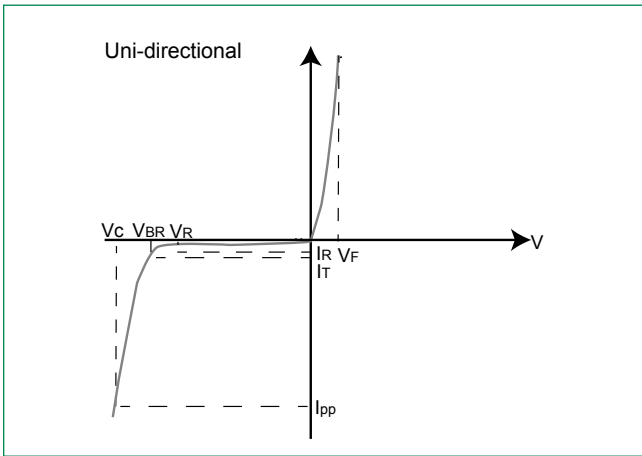
### Electrical Characteristics (T<sub>A</sub>=25°C unless otherwise noted)

Part Number (Uni)	Part Number (Bi)	Marking		Reverse Stand off Voltage V <sub>R</sub> (Volts)	Breakdown Voltage V <sub>BR</sub> (Volts) @ I <sub>T</sub>		Test Current I <sub>T</sub> (mA)	Maximum Clamping Voltage V <sub>C</sub> @ I <sub>PP</sub> (V)	Maximum Peak Pulse Current I <sub>PP</sub> (A)	Maximum Reverse Leakage I <sub>R</sub> @ V <sub>R</sub> (µA)	Maximum Temperature coefficient of V <sub>BR</sub> (%/C)	Agency Approval 
		UNI	BI		MIN	MAX						
SMBJ5.0A	SMBJ5.0CA	KE	AE	5.0	6.40	7.00	10	9.2	65.3	800	0.041	X
SMBJ6.0A	SMBJ6.0CA	KG	AG	6.0	6.67	7.37	10	10.3	58.3	800	0.046	X
SMBJ6.5A	SMBJ6.5CA	KK	AK	6.5	7.22	7.98	10	11.2	53.6	500	0.052	X
SMBJ7.0A	SMBJ7.0CA	KM	AM	7.0	7.78	8.60	10	12.0	50.0	200	0.058	X
SMBJ7.5A	SMBJ7.5CA	KP	AP	7.5	8.33	9.21	1	12.9	46.6	100	0.061	X
SMBJ8.0A	SMBJ8.0CA	KR	AR	8.0	8.89	9.83	1	13.6	44.2	50	0.064	X
SMBJ8.5A	SMBJ8.5CA	KT	AT	8.5	9.44	10.40	1	14.4	41.7	20	0.066	X
SMBJ9.0A	SMBJ9.0CA	KV	AV	9.0	10.00	11.10	1	15.4	39.0	10	0.069	X
SMBJ10A	SMBJ10CA	KX	AX	10.0	11.10	12.30	1	17.0	35.3	5	0.071	X
SMBJ11A	SMBJ11CA	KZ	AZ	11.0	12.20	13.50	1	18.2	33.0	1	0.074	X
SMBJ12A	SMBJ12CA	LE	BE	12.0	13.30	14.70	1	19.9	30.2	1	0.075	X
SMBJ13A	SMBJ13CA	LG	BG	13.0	14.40	15.90	1	21.5	28.0	1	0.076	X
SMBJ14A	SMBJ14CA	LK	BK	14.0	15.60	17.20	1	23.2	25.9	1	0.080	X
SMBJ15A	SMBJ15CA	LM	BM	15.0	16.70	18.50	1	24.4	24.6	1	0.083	X
SMBJ16A	SMBJ16CA	LP	BP	16.0	17.80	19.70	1	26.0	23.1	1	0.084	X
SMBJ17A	SMBJ17CA	LR	BR	17.0	18.90	20.90	1	27.6	21.8	1	0.085	X
SMBJ18A	SMBJ18CA	LT	BT	18.0	20.00	22.10	1	29.2	20.6	1	0.088	X
SMBJ20A	SMBJ20CA	LV	BV	20.0	22.20	24.50	1	32.4	18.6	1	0.091	X
SMBJ22A	SMBJ22CA	LX	BX	22.0	24.40	26.90	1	35.5	16.9	1	0.092	X
SMBJ24A	SMBJ24CA	LZ	BZ	24.0	26.70	29.50	1	38.9	15.5	1	0.092	X
SMBJ26A	SMBJ26CA	ME	CE	26.0	28.90	31.90	1	42.1	14.3	1	0.093	X
SMBJ28A	SMBJ28CA	MG	CG	28.0	31.10	34.40	1	45.4	13.3	1	0.094	X
SMBJ30A	SMBJ30CA	MK	CK	30.0	33.30	36.80	1	48.4	12.4	1	0.096	X
SMBJ33A	SMBJ33CA	MM	CM	33.0	36.70	40.60	1	53.3	11.3	1	0.097	X
SMBJ36A	SMBJ36CA	MP	CP	36.0	40.00	44.20	1	58.1	10.4	1	0.098	X
SMBJ40A	SMBJ40CA	MR	CR	40.0	44.40	49.10	1	64.5	9.3	1	0.099	X
SMBJ43A	SMBJ43CA	MT	CT	43.0	47.80	52.80	1	69.4	8.7	1	0.100	X
SMBJ45A	SMBJ45CA	MV	CV	45.0	50.00	55.30	1	72.7	8.3	1	0.101	X
SMBJ48A	SMBJ48CA	MX	CX	48.0	53.30	58.90	1	77.4	7.8	1	0.101	X
SMBJ51A	SMBJ51CA	MZ	CZ	51.0	56.70	62.70	1	82.4	7.3	1	0.101	X
SMBJ54A	SMBJ54CA	NE	DE	54.0	60.00	66.30	1	87.1	6.9	1	0.102	X
SMBJ58A	SMBJ58CA	NG	DG	58.0	64.40	71.20	1	93.6	6.5	1	0.103	X
SMBJ60A	SMBJ60CA	NK	DK	60.0	66.70	73.70	1	96.8	6.2	1	0.103	X
SMBJ64A	SMBJ64CA	NM	DM	64.0	71.10	78.60	1	103.0	5.9	1	0.104	X
SMBJ70A	SMBJ70CA	NP	DP	70.0	77.80	86.00	1	113.0	5.3	1	0.105	X
SMBJ75A	SMBJ75CA	NR	DR	75.0	83.30	92.10	1	121.0	5.0	1	0.106	X
SMBJ78A	SMBJ78CA	NT	DT	78.0	86.70	95.80	1	126.0	4.8	1	0.106	X
SMBJ85A	SMBJ85CA	NV	DV	85.0	94.40	104.00	1	137.0	4.4	1	0.106	X
SMBJ90A	SMBJ90CA	NX	DX	90.0	100.00	111.00	1	146.0	4.1	1	0.107	X
SMBJ100A	SMBJ100CA	NZ	DZ	100.0	111.00	123.00	1	162.0	3.7	1	0.107	X
SMBJ110A	SMBJ110CA	PE	EE	110.0	122.00	135.00	1	177.0	3.4	1	0.107	X
SMBJ120A	SMBJ120CA	PG	EG	120.0	133.00	147.00	1	193.0	3.1	1	0.108	X
SMBJ130A	SMBJ130CA	PK	EK	130.0	144.00	159.00	1	209.0	2.9	1	0.108	X
SMBJ150A	SMBJ150CA	PM	EM	150.0	167.00	185.00	1	243.0	2.5	1	0.108	X
SMBJ160A	SMBJ160CA	PP	EP	160.0	178.00	197.00	1	259.0	2.3	1	0.108	X
SMBJ170A	SMBJ170CA	PR	ER	170.0	189.00	209.00	1	275.0	2.2	1	0.108	X
SMBJ180A	SMBJ180CA	PT	ET	180.0	201.00	222.00	1	292.0	2.1	1	0.108	X
SMBJ188A	SMBJ188CA	PB	EB	188.0	209.00	231.00	1	304.0	2.0	1	0.110	X
SMBJ200A	SMBJ200CA	PV	EV	200.0	224.00	247.00	1	324.0	1.9	1	0.110	X
SMBJ220A	SMBJ220CA	PX	EX	220.0	246.00	272.00	1	356.0	1.7	1	0.110	X
SMBJ250A	SMBJ250CA	PZ	EZ	250.0	279.00	309.00	1	405.0	1.5	1	0.110	X
SMBJ300A*	SMBJ300CA*	QE	FE	300.0	335.00	371.00	1	486.0	1.7	1	0.112	X
SMBJ350A*	SMBJ350CA*	QG	FG	350.0	391.00	432.00	1	567.0	1.5	1	0.112	X
SMBJ400A*	SMBJ400CA*	QK	FK	400.0	447.00	494.00	1	648.0	1.3	1	0.112	X
SMBJ440A*	SMBJ440CA*	QM	FM	440.0	492.00	543.00	1	713.0	1.1	1	0.112	X

**Notes:**

For bidirectional type having V<sub>a</sub> of 10 volts and less, the I<sub>s</sub> limit is double.  
 For stack-die parts, use \* to label the part number.

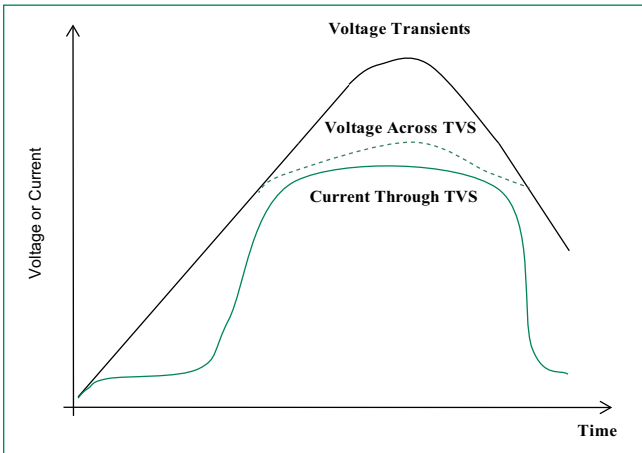
**I-V Curve Characteristics**



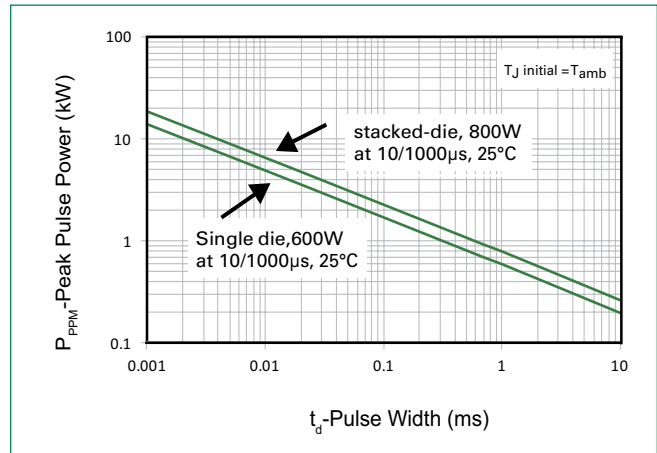
- $P_{PPM}$  Peak Pulse Power Dissipation** – Max power dissipation
- $V_s$  Stand-off Voltage** – Maximum voltage that can be applied to the TVS without operation
- $V_{BR}$  Breakdown Voltage** – Maximum voltage that flows through the TVS at a specified test current ( $I_T$ )
- $V_C$  Clamping Voltage** – Peak voltage measured across the TVS at a specified  $I_{ppm}$  (peak impulse current)
- $I_R$  Reverse Leakage Current** – Current measured at  $V_s$
- $V_F$  Forward Voltage Drop for Uni-directional**

**Ratings and Characteristic Curves** ( $T_A=25^\circ\text{C}$  unless otherwise noted)

**Figure 1 - TVS Transients Clamping Waveform**

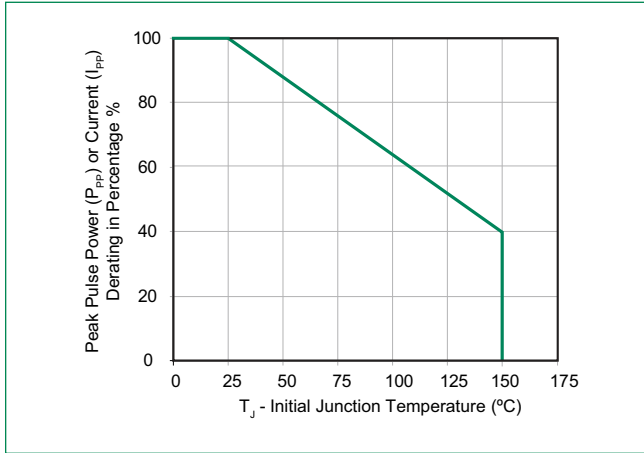


**Figure 2 - Peak Pulse Power Rating**



**Ratings and Characteristic Curves** ( $T_A=25^\circ\text{C}$  unless otherwise noted) (Continued)

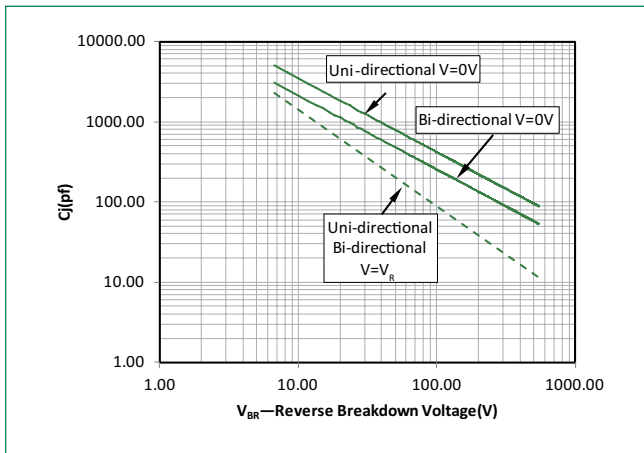
**Figure 3 - Peak Pulse Power Derating Curve**



**Figure 4 - Pulse Waveform**



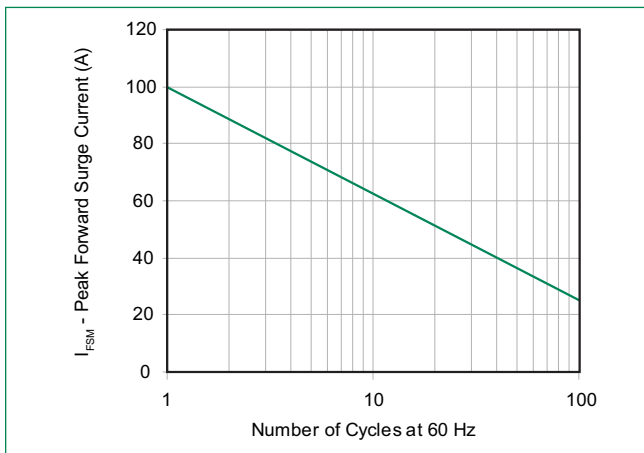
**Figure 5 - Typical Junction Capacitance**



**Figure 6 - Typical Transient Thermal Impedance**



**Figure 7 - Maximum Non-Repetitive Peak Forward Surge Current Uni-Directional Only**

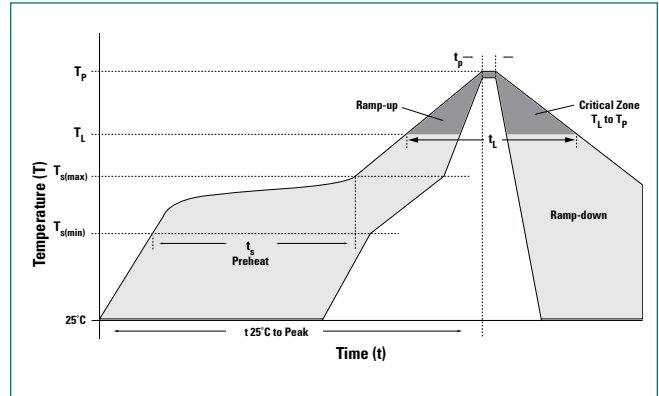


**Figure 8 - Peak Forward Voltage Drop vs Peak Forward Current (Typical Values)**



**Soldering Parameters**

<b>Reflow Condition</b>		Lead-free assembly
<b>Pre Heat</b>	- Temperature Min ( $T_{s(min)}$ )	150°C
	- Temperature Max ( $T_{s(max)}$ )	200°C
	- Time (min to max) ( $t_s$ )	60 – 120 secs
<b>Average ramp up rate (Liquidus Temp (<math>T_L</math>) to peak)</b>		3°C/second max
<b><math>T_{s(max)}</math> to <math>T_L</math> - Ramp-up Rate</b>		3°C/second max
<b>Reflow</b>	- Temperature ( $T_L$ ) (Liquidus)	217°C
	- Time (min to max) ( $t_L$ )	60 – 150 seconds
<b>Peak Temperature (<math>T_p</math>)</b>		260 <sup>+0/-5</sup> °C
<b>Time within 5°C of actual peak Temperature (<math>t_p</math>)</b>		30 seconds max
<b>Ramp-down Rate</b>		6°C/second max
<b>Time 25°C to peak Temperature (<math>T_p</math>)</b>		8 minutes Max.
<b>Do not exceed</b>		260°C



**Physical Specifications**

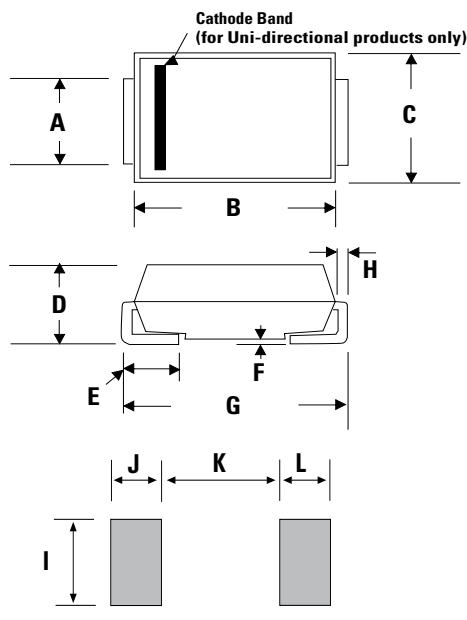
<b>Weight</b>	0.003 ounce, 0.093 grams
<b>Case</b>	JEDEC DO214AA. Molded plastic body over glass passivated junction
<b>Polarity</b>	Color band denotes cathode except Bidirectional
<b>Terminal</b>	Matte Tin-plated leads, Solderable per JESD22-B102

**Environmental Specifications**

<b>High Temp. Storage</b>	JESD22-A103
<b>HTRB</b>	JESD22-A108
<b>Temperature Cycling</b>	JESD22-A104
<b>MSL</b>	JEDEC-J-STD-020, Level 1
<b>H3TRB</b>	JESD22-A101
<b>RSH</b>	JESD22-A111

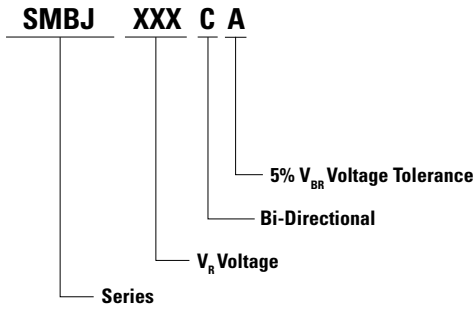
**Dimensions**

**DO-214AA (SMB J-Bend)**



Dimensions	Inches		Millimeters	
	Min	Max	Min	Max
A	0.076	0.086	1.930	2.200
B	0.160	0.187	4.060	4.750
C	0.130	0.155	3.300	3.940
D	0.078	0.103	1.990	2.610
E	0.030	0.060	0.760	1.520
F	-	0.008	-	0.203
G	0.205	0.220	5.210	5.590
H	0.006	0.012	0.152	0.305
I	0.089	-	2.260	-
J	0.085	-	2.160	-
K	-	0.107	-	2.740
L	0.085	-	2.160	-

**Part Numbering System**



**Part Marking System**



**Packaging**

Part number	Component Package	Quantity	Packaging Option	Packaging Specification
SMBJxxxXX	DO-214AA	3000	Tape & Reel - 12mm tape/13" reel	EIA STD RS-481

**Tape and Reel Specification**

