

Logic Gate Optocoupler, High CMR, Bi-Directional FOD8012A

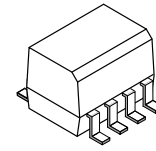

SOIC8
 CASE 751DZ

Description

The FOD8012A is a half duplex, bi-directional, high-speed logic gate Optocoupler, which supports isolated communications allowing digital signals to communicate between systems without conducting ground loops or hazardous voltages. It utilizes onsemi's patented coplanar packaging technology, OPTOPLANAR[®], and optimized IC design to achieve minimum 20 kV/μs Common Mode Noise Rejection (CMR) rating.

This high-speed logic gate optocoupler is highly integrated with 2 optically coupled channels arranged in bi-directional configuration, and housed in a compact 8-pin small outline package. Each optocoupler channel consists of a high-speed AlGaAs LED driven by a CMOS buffer IC coupled to a CMOS detector IC. The detector IC comprises of an integrated photodiode, a high-speed trans-impedance amplifier and a voltage comparator with an output driver. The CMOS technology coupled to the high efficiency of the LED achieves low power consumption as well as very high speed (60 ns propagation delay, 15 ns pulse width distortion).

Features

- Half Duplex, Bi-Directional
- 20 kV/μs Minimum Common Mode Rejection
- High Speed:
 - ◆ 15 Mbit/s Data Rate (NRZ)
 - ◆ 60 ns Maximum Propagation Delay
 - ◆ 15 ns Maximum Pulse Width Distortion
 - ◆ 30 ns Maximum Propagation Delay Skew
- 3.3 V and 5 V CMOS Compatibility
- Extended Industrial Temperature Range, -40 to +110°C Temperature Range
- Safety and Regulatory Approvals:
 - ◆ UL1577, 3750 VAC_{RMS} for 1 min.
 - ◆ DIN EN/IEC60747-5-5 (approval pending)

Applications

- Industrial Fieldbus Communications
 - ◆ DeviceNet, CAN, RS485
- Microprocessor System Interface
 - ◆ SPI, I²C
- Programmable Logic Control
- Isolated Data Acquisition System
- Voltage Level Translator

Related Resources

- [FOD8001/D](#), High Noise Immunity, 3.3 V/5 V Logic Gate Optocoupler Datasheet

MARKING DIAGRAM

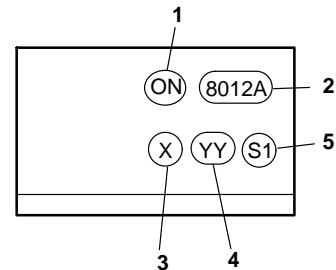

1. ON = onsemi Logo
2. 8012A = Device Number
3. X = One-Digit Year Code, e.g. '8'
4. YY = Two Digit Work Week Ranging from '01' to '53'
5. S1 = Assembly Package Code

ORDERING INFORMATION

See detailed ordering and shipping information on page 9 of this data sheet.

FOD8012A

TRUTH TABLE

V_{IN}	LED	V_O
High	OFF	High
Low	ON	Low

NOTE: When not communicating, V_{IN} must be in static high logic condition.

Functional Schematic

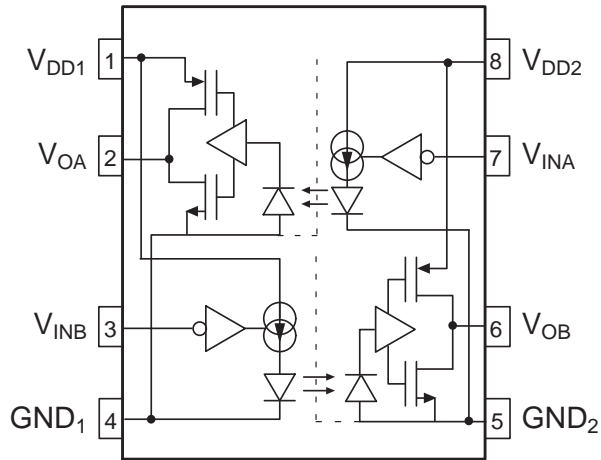

0.1 μ F bypass capacitor required from V_{DD} to GND

Figure 1. Functional Schematic

PIN DEFINITIONS

Pin Number	Pin Name	Description
1	V_{DD1}	Supply Voltage to Channel-A detector IC and Channel-B buffer IC
2	V_{OA}	Output Voltage from Channel-A detector IC
3	V_{INB}	Input Voltage to Channel-B buffer IC
4	GND_1	Ground for Channel-A detector IC and Channel-B buffer IC
5	GND_2	Ground for Channel-A buffer IC and Channel-B detector IC
6	V_{OB}	Output Voltage from Channel-B detector IC
7	V_{INA}	Input Voltage to Channel-A buffer IC
8	V_{DD2}	Supply Voltage to Channel-A buffer IC and Channel-B detector IC

FOD8012A

ABSOLUTE MAXIMUM RATINGS (T_A = 25°C unless otherwise specified)

Symbol	Parameter	Value	Units
T _{STG}	Storage Temperature	-40 to +125	°C
T _{OPR}	Operating Temperature	-40 to +110	°C
T _J	Junction Temperature	-40 to +130	°C
T _{SOL}	Lead Solder Temperature (Refer to Reflow Temperature Profile)	260 for 10 s	°C
V _{DD1} , V _{DD2}	Supply Voltage	0 to 6.0	V
V _{IA} , V _{IB}	Input Voltage	-0.5 to V _{DD} + 0.5	V
I _{IA} , I _{IB}	Input DC Current	-10 to +10	μA
V _{OA} , V _{OB}	Output Voltage	-0.5 to V _{DD} + 0.5	V
I _{OA} , I _{OB}	Average Output Current	10	mA
PD _I	Input Power Dissipation (Note 1)	60	mW
PD _O	Output Power Dissipation (Note 1)	60	mW

Stresses exceeding those listed in the Maximum Ratings table may damage the device. If any of these limits are exceeded, device functionality should not be assumed, damage may occur and reliability may be affected.

1. No derating required.

RECOMMENDED OPERATING CONDITIONS

Symbol	Parameter	Min.	Max.	Unit
T _A	Ambient Operating Temperature	-40	+110	°C
V _{DD1} , V _{DD2}	Supply Voltages (3.3 V Operation) (Note 2)	3.0	3.6	V
	Supply Voltages (5.0 V Operation) (Note 2)	4.5	5.5	
V _{IH}	Logic High Input Voltage	2.0	V _{DD}	V
V _{IL}	Logic Low Input Voltage	0	0.8	V
t _r , t _f	Input Signal Rise and Fall Time		1.0	ms

Functional operation above the stresses listed in the Recommended Operating Ranges is not implied. Extended exposure to stresses beyond the Recommended Operating Ranges limits may affect device reliability.

2. 0.1 μF bypass capacitor must be connected between Pin 1 and 4, and 5 and 8. The capacitors should be kept close to the supply pins.

ISOLATION CHARACTERISTICS (Apply over all recommended conditions, typical value is measured at T_A = 25°C)

Symbol	Characteristics	Test Conditions	Min.	Typ.	Max.	Unit
V _{ISO}	Input-Output Isolation Voltage	f = 60 Hz, t = 1.0 min., I _{I-O} ≤ 10 μA (Notes 3, 4)	3750			V _{ACRMS}
R _{ISO}	Isolation Resistance	V _{I-O} = 500 V (Note 3)	10 ¹¹			Ω
C _{ISO}	Isolation Capacitance	V _{I-O} = 0 V, f = 1.0 MHz (Note 3)		0.2		pF

3. Device is considered a two terminal device: Pins 1, 2, 3 and 4 are shorted together and Pins 5, 6, 7 and 8 are shorted together.

4. 3,750 V_{ACRMS} for 1 minute duration is equivalent to 4,500 V_{ACRMS} for 1 second duration.

ELECTRICAL CHARACTERISTICS (T_A = -40°C to +110°C, 3.0 V ≤ V_{DD} ≤ 5.5 V, unless otherwise specified.

Apply over all recommended conditions, typical value is measured at V_{DD1} = V_{DD2} = +3.3 V, T_A = 25°C)

Symbol	Parameter	Conditions	Min.	Typ.	Max.	Units
I _{DD1L} , I _{DD2L}	Logic Low Supply Current	V _{IA} , V _{IB} = 0 V		5.8	8.0	mA
I _{DD1H} , I _{DD2H}	Logic High Supply Current	V _{IA} , V _{IB} = V _{DD}		2.5	4.0	mA
I _{IA} , I _{IB}	Input Current		-10		+10	μA
V _{OH}	Logic High Output Voltage	I _O = -20 μA, V _I = V _{IH} , V _{DD} = 3.3 V	3.2	3.3		V
		I _O = -4 mA, V _I = V _{IH} , V _{DD} = 3.3 V	3.0	3.1		
		I _O = -20 μA, V _I = V _{IH} , V _{DD} = 5 V	4.9	5.0		
		I _O = -4 mA, V _I = V _{IH} , V _{DD} = 5 V	4.7	4.8		
V _{OL}	Logic Low Output Voltage	I _O = 20 μA, V _I = V _{IL} , V _{DD} = 3.3 V or 5 V		0	0.1	V
		I _O = 4 mA, V _I = V _{IL} , V _{DD} = 3.3 V or 5 V		0.26	0.6	

Product parametric performance is indicated in the Electrical Characteristics for the listed test conditions, unless otherwise noted. Product performance may not be indicated by the Electrical Characteristics if operated under different conditions.

FOD8012A

SWITCHING CHARACTERISTICS ($T_A = -40^\circ\text{C}$ to $+110^\circ\text{C}$, $3.0\text{ V} \leq V_{DD} \leq 5.5\text{ V}$, unless otherwise specified.

Apply over all recommended conditions, typical value is measured at $V_{DD1} = V_{DD2} = +3.3\text{ V}$, $T_A = 25^\circ\text{C}$)

Symbol	Parameter	Conditions	Min.	Typ.	Max.	Unit
	Data Rate				15	Mbit/s
t_{PHL}	Propagation Delay Time to Logic Low Output	$PW = 66.7\text{ ns}$, $C_L = 15\text{ pF}$		37	60	ns
t_{PLH}	Propagation Delay Time to Logic High Output	$PW = 66.7\text{ ns}$, $C_L = 15\text{ pF}$		40	60	ns
PWD	Pulse Width Distortion, $ t_{PHL} - t_{PLH} $	$PW = 66.7\text{ ns}$, $C_L = 15\text{ pF}$ (Note 5)		3	15	ns
$t_{PSK(CC)}$	Channel-Channel Skew	$PW = 66.7\text{ ns}$, $C_L = 15\text{ pF}$ (Note 6)		12	25	ns
$t_{PSK(PP)}$	Part-Part Skew	$PW = 66.7\text{ ns}$, $C_L = 15\text{ pF}$ (Note 7)			30	ns
t_R	Output Rise Time (10% to 90%)	$PW = 66.7\text{ ns}$, $C_L = 15\text{ pF}$		6.5		ns
t_F	Output Fall Time (90% to 10%)	$PW = 66.7\text{ ns}$, $C_L = 15\text{ pF}$		6.5		ns
$ CM_H $	Common Mode Transient Immunity at Output High	$V_I = V_{DD1}$, $V_O > 0.8 V_{DD1}$, $V_{CM} = 1000\text{ V}$ (Note 8)	20	40		kV/ μs
$ CM_L $	Common Mode Transient Immunity at Output Low	$V_I = 0\text{ V}$, $V_O < 0.8\text{ V}$, $V_{CM} = 1000\text{ V}$ (Note 8)	20	40		kV/ μs

5. PWD is equal to the magnitude of the worst case difference in t_{PHL} and/or t_{PLH} that will be seen for one channel switching, while holding the other channel output at a low or high state, or while both channels are in synchronous data transmission mode.
6. $t_{PSK(CC)}$ is equal to the magnitude of the worst case difference in t_{PHL} and/or t_{PLH} that will be seen between the two channels within a single device.
7. $t_{PSK(PP)}$ is equal to the magnitude of the worst case difference in t_{PHL} and/or t_{PLH} that will be seen between any two units from the same manufacturing date code that are operated at same case temperature, at same operating conditions, with equal loads.
8. Common mode transient immunity at output high is the maximum tolerable positive dV_{cm}/dt on the leading edge of the common mode impulse signal, V_{cm} , to assure that the output will remain high. Common mode transient immunity at output low is the maximum tolerable negative dV_{cm}/dt on the trailing edge of the common pulse signal, V_{cm} , to assure that the output will remain low.

FOD8012A

TYPICAL PERFORMANCE CURVES

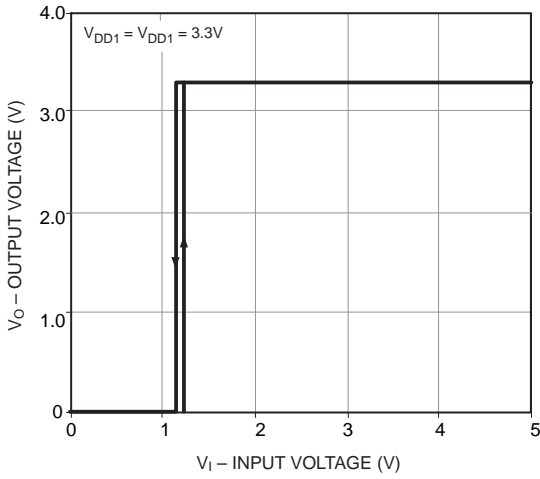

Figure 2. Typical Output Voltage vs. Input Voltage (Channel A & B)

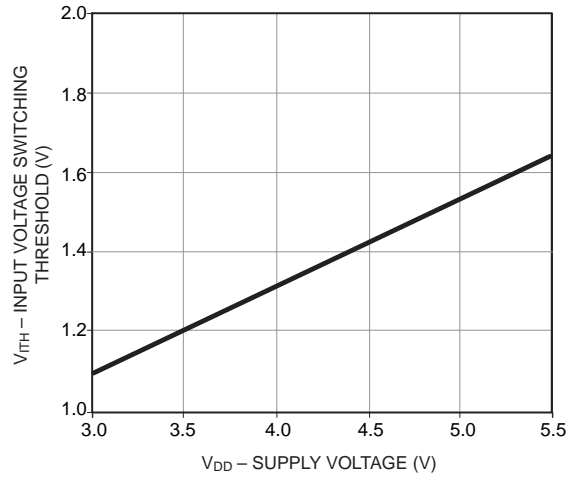

Figure 3. Typical Input Voltage Switching Threshold vs. Input Supply Voltage (Channel A & B)

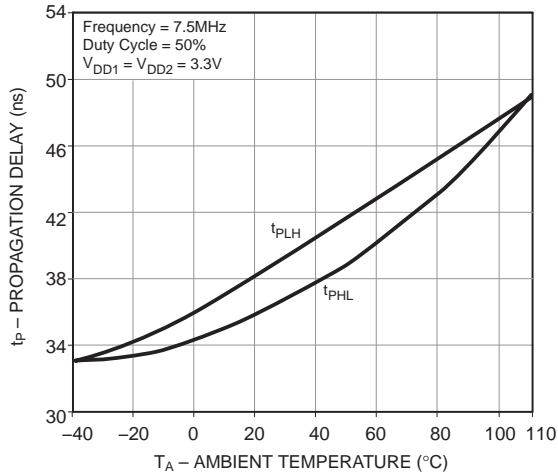

Figure 4. Typical Propagation Delay vs. Ambient Temperature (Channel A & B)

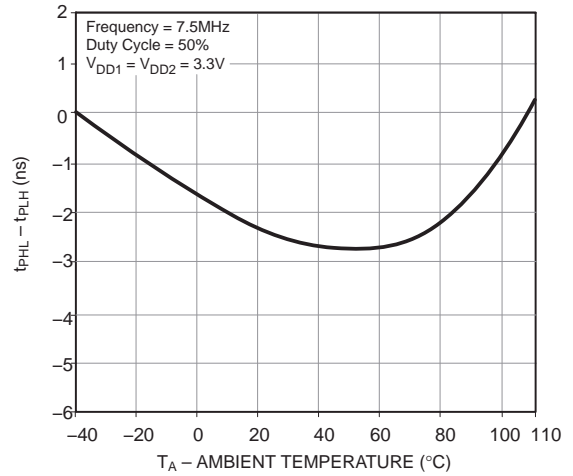

Figure 5. Typical $t_{PHL} - t_{PLH}$ vs. Ambient Temperature (Channel A & B)

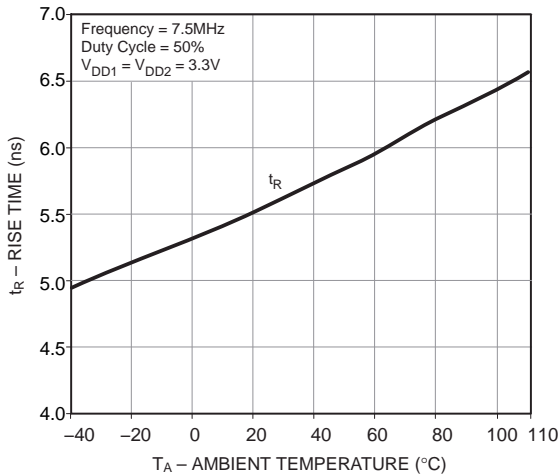

Figure 6. Typical Rise Time vs. Ambient Temperature (Channel A & B)

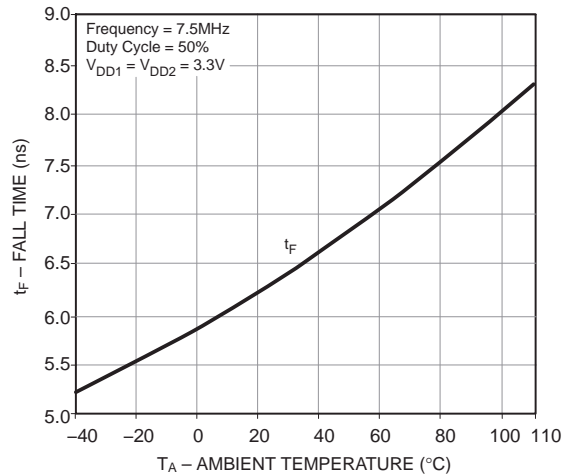

Figure 7. Typical Fall Time vs. Ambient Temperature (Channel A & B)

TYPICAL PERFORMANCE CURVES (Continued)

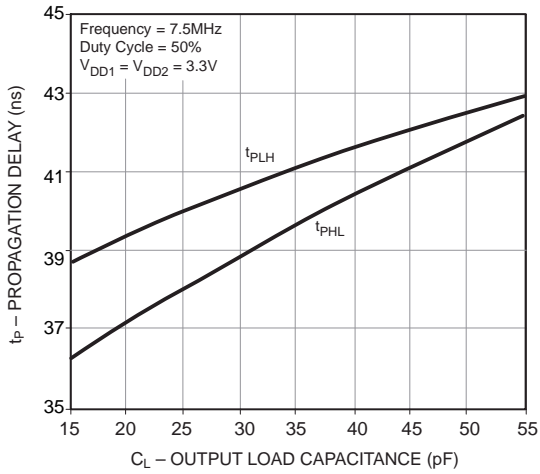

Figure 8. Typical Propagation Delay vs. Output Load Capacitance (Channel A & B)

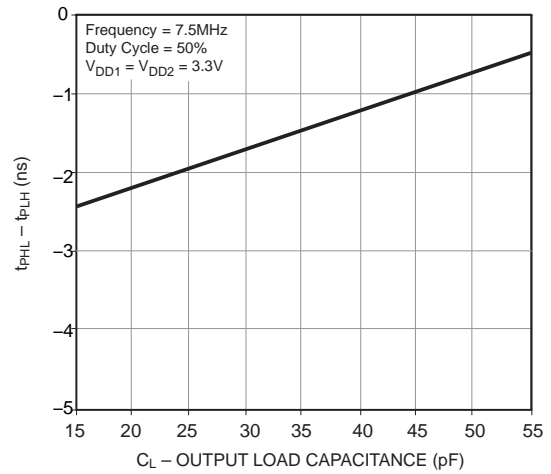

Figure 9. Typical $t_{PHL} - t_{PLH}$ vs. Output Load Capacitance (Channel A & B)

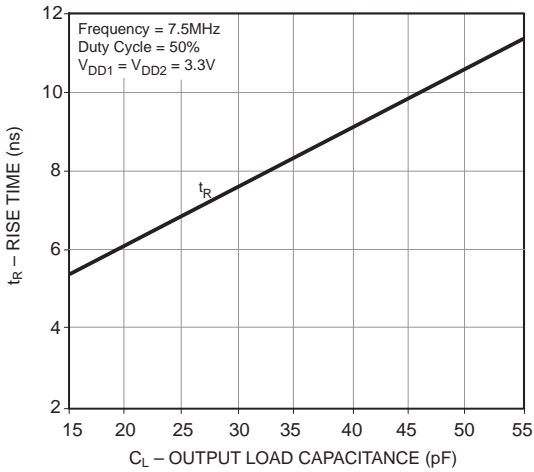

Figure 10. Typical Rise Time vs. Output Load Capacitance (Channel A & B)

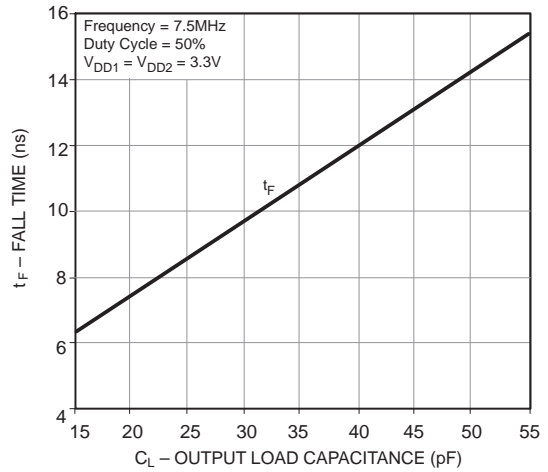

Figure 11. Typical Fall Time vs. Output Load Capacitance (Channel A & B)

FOD8012A

TYPICAL PERFORMANCE CURVES (Continued)

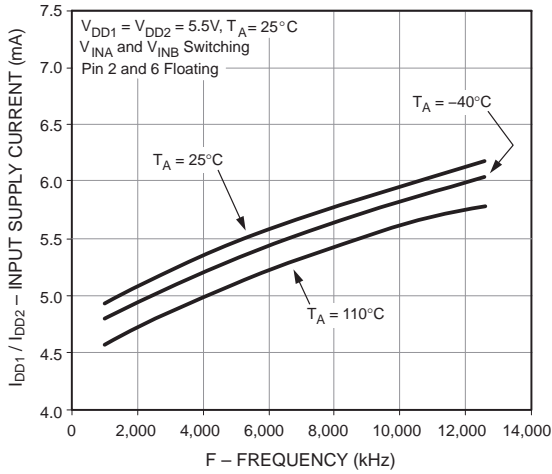

Figure 12. Typical I_{DD1}/I_{DD2} Supply Current vs. Frequency

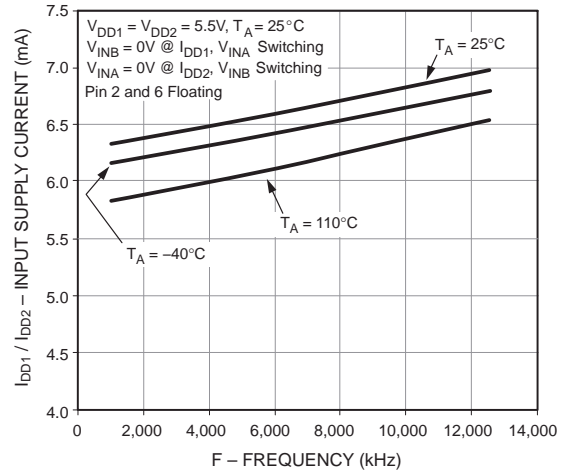

Figure 13. Typical I_{DD1}/I_{DD2} Supply Current vs. Frequency

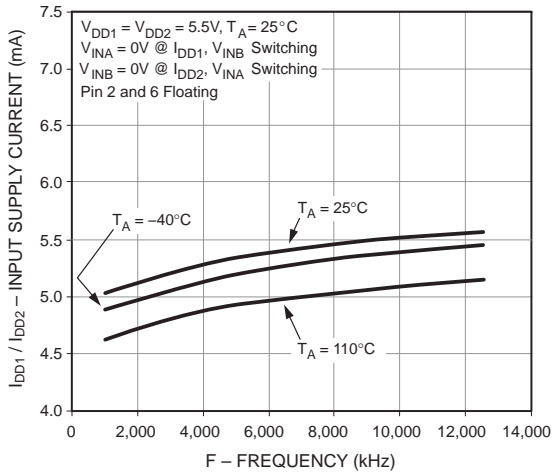

Figure 14. Typical I_{DD1}/I_{DD2} Supply Current vs. Frequency

FOD8012A

TEST CIRCUITS

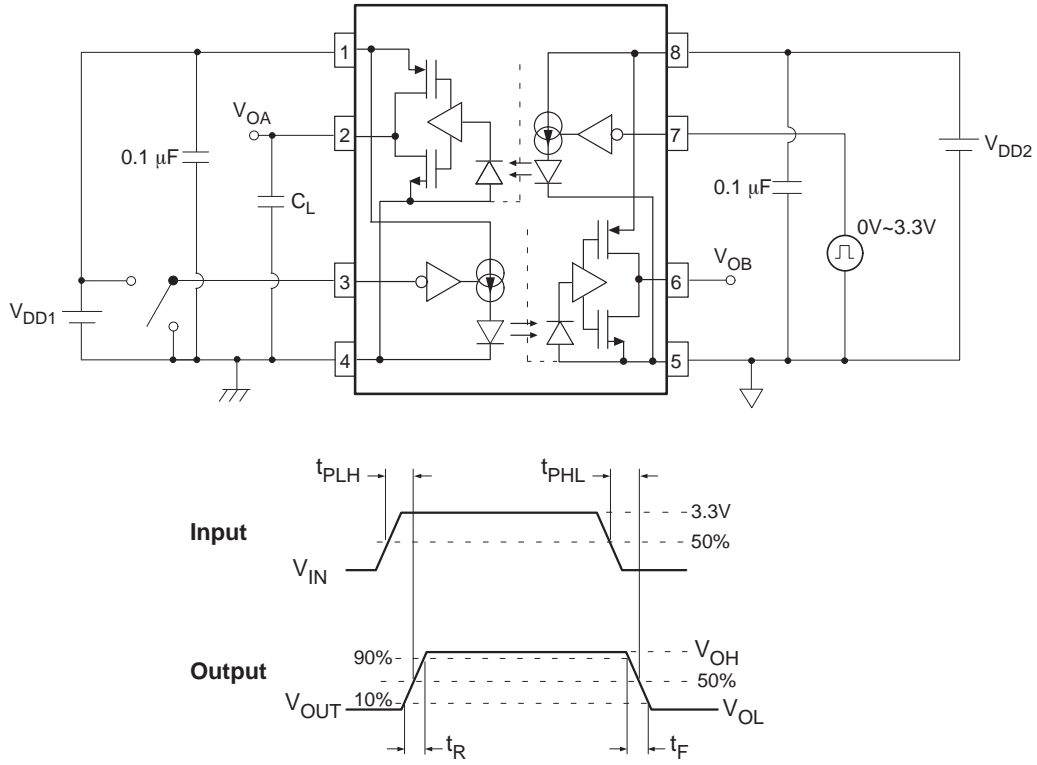

Figure 15. Test Circuit for Propagation Delay Time and Rise Time, Fall Time

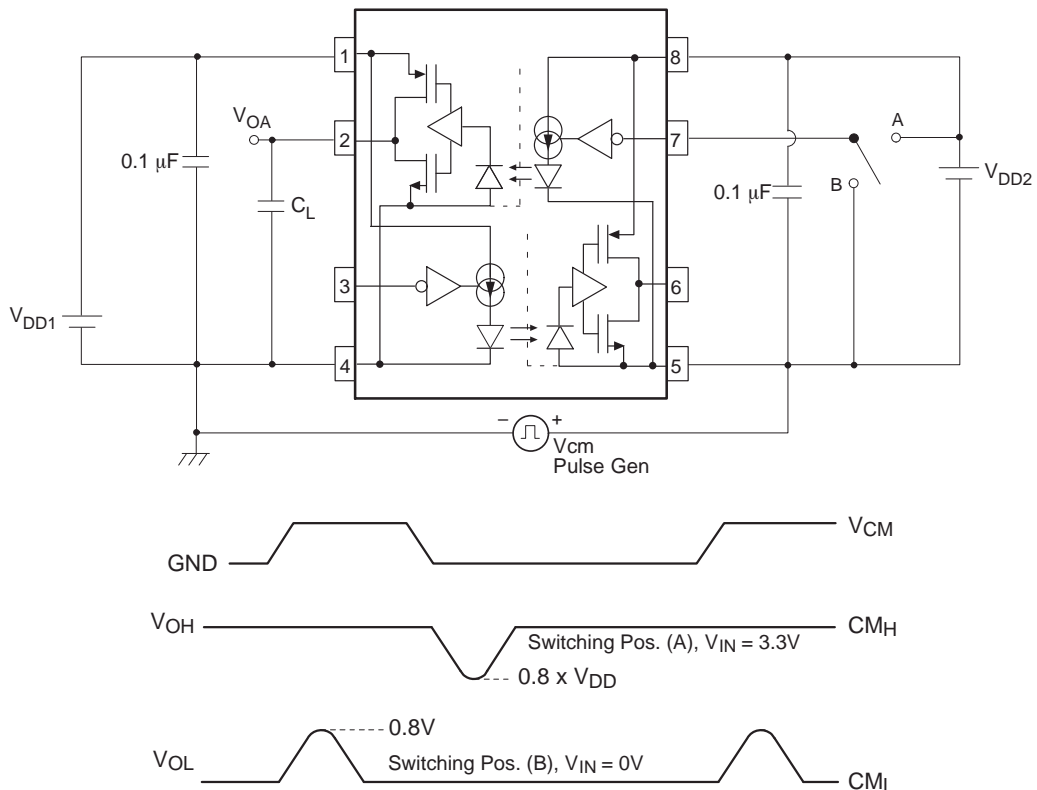

Figure 16. Test Circuit for Instantaneous Common Mode Rejection Voltage

FOD8012A

ORDERING INFORMATION

Option	Order Entry Identifier	Package	Packing Method†
No Suffix	FOD8012A	SOIC8 (Pb-Free)*	Tube (50 Units per Tube)
R2	FOD8012AR2	SOIC8 (Pb-Free)*	Tape and Reel (2,500 Units per Reel)

†For information on tape and reel specifications, including part orientation and tape sizes, please refer to our Tape and Reel Packaging Specifications Brochure, BRD8011/D.

*All packages are lead free per JEDEC: J-STD-020B standard.

REFLOW PROFILE

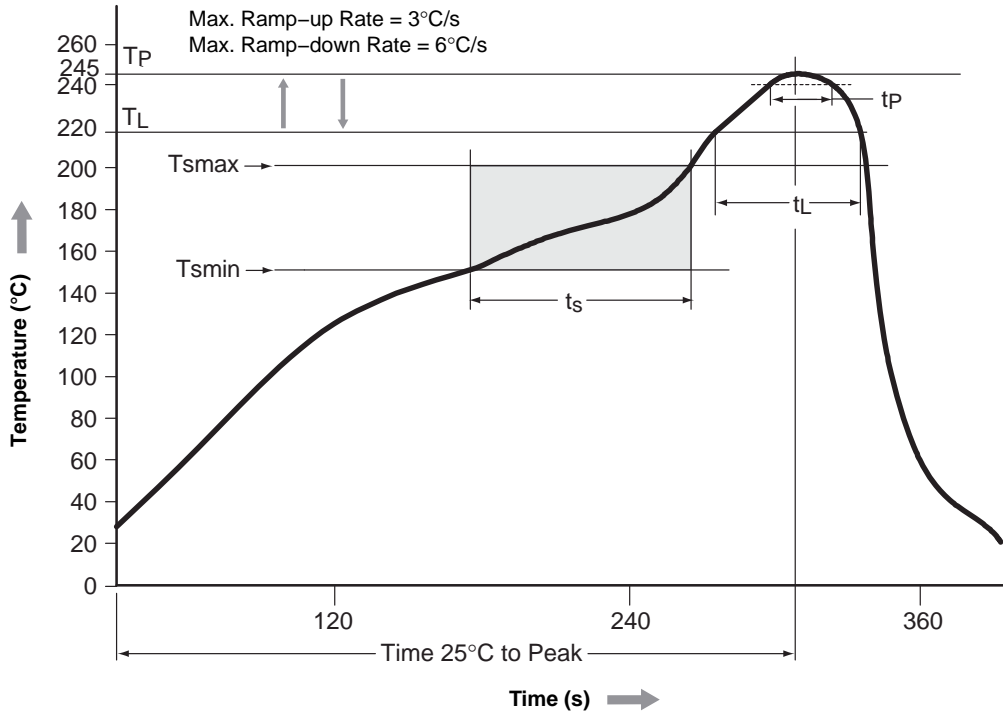

Profile Feature	Pb-Free Assembly Profile
Temperature Min. (Tsmin)	150°C
Temperature Max. (Tsmax)	200°C
Time (ts) from (Tsmin to Tsmax)	60 – 120 s
Ramp-up Rate (tL to tp)	3°C/s max.
Liquidous Temperature (TL)	217°C
Time (tL) Maintained Above (TL)	60 – 150 s
Peak Body Package Temperature	245°C + 0°C / -5°C
Time (tp) within 5°C of 245°C	30 s
Ramp-down Rate (TP to TL)	6°C/s max.
Time 25°C to Peak Temperature	8 minutes max.

OPTOPLANAR is a registered trademark of Semiconductor Components Industries, LLC dba "onsemi" or its affiliates and/or subsidiaries in the United States and/or other countries.

SOIC8
CASE 751DZ
ISSUE O

DATE 30 SEP 2016

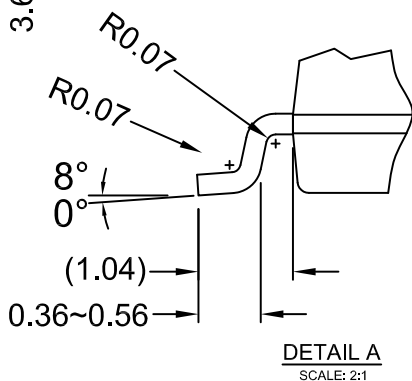
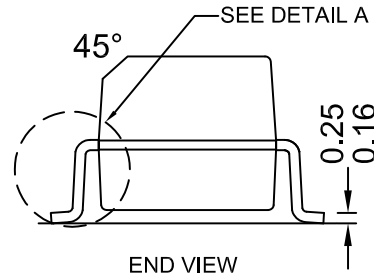
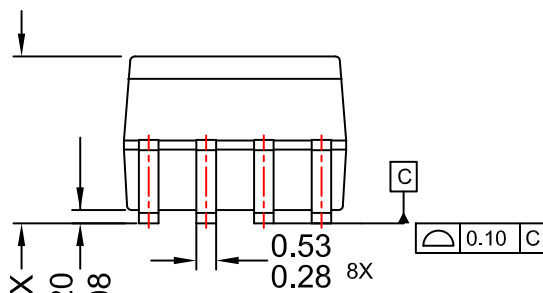
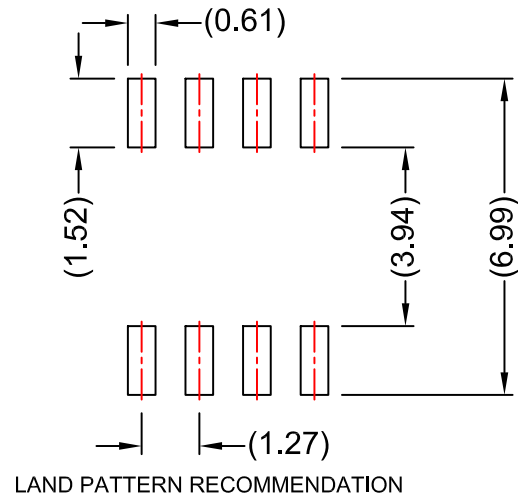
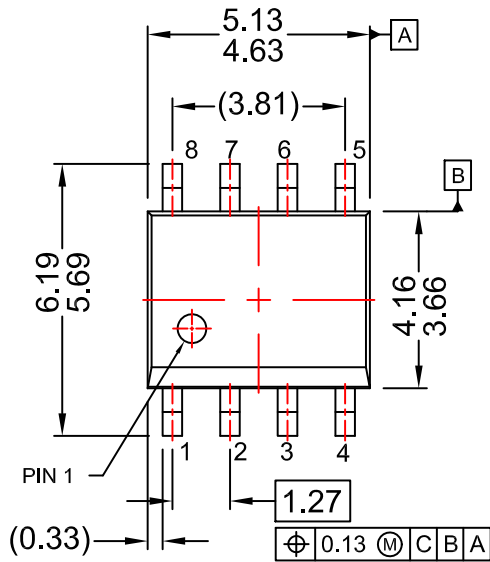

NOTES:

- A) NO STANDARD APPLIES TO THIS PACKAGE
- B) ALL DIMENSIONS ARE IN MILLIMETERS.
- C) DIMENSIONS DO NOT INCLUDE MOLD FLASH OR BURRS.
- D) LANDPATTERN STANDARD: SOIC127P600X175-8M.

DOCUMENT NUMBER:	98AON13733G	Electronic versions are uncontrolled except when accessed directly from the Document Repository. Printed versions are uncontrolled except when stamped "CONTROLLED COPY" in red.
DESCRIPTION:	SOIC8	PAGE 1 OF 1

onsemi and ONSEMI are trademarks of Semiconductor Components Industries, LLC dba onsemi or its subsidiaries in the United States and/or other countries. onsemi reserves the right to make changes without further notice to any products herein. onsemi makes no warranty, representation or guarantee regarding the suitability of its products for any particular purpose, nor does onsemi assume any liability arising out of the application or use of any product or circuit, and specifically disclaims any and all liability, including without limitation special, consequential or incidental damages. onsemi does not convey any license under its patent rights nor the rights of others.

onsemi, **Onsemi**, and other names, marks, and brands are registered and/or common law trademarks of Semiconductor Components Industries, LLC dba "**onsemi**" or its affiliates and/or subsidiaries in the United States and/or other countries. **onsemi** owns the rights to a number of patents, trademarks, copyrights, trade secrets, and other intellectual property. A listing of **onsemi**'s product/patent coverage may be accessed at www.onsemi.com/site/pdf/Patent-Marking.pdf. **onsemi** reserves the right to make changes at any time to any products or information herein, without notice. The information herein is provided "as-is" and **onsemi** makes no warranty, representation or guarantee regarding the accuracy of the information, product features, availability, functionality, or suitability of its products for any particular purpose, nor does **onsemi** assume any liability arising out of the application or use of any product or circuit, and specifically disclaims any and all liability, including without limitation special, consequential or incidental damages. Buyer is responsible for its products and applications using **onsemi** products, including compliance with all laws, regulations and safety requirements or standards, regardless of any support or applications information provided by **onsemi**. "Typical" parameters which may be provided in **onsemi** data sheets and/or specifications can and do vary in different applications and actual performance may vary over time. All operating parameters, including "Typicals" must be validated for each customer application by customer's technical experts. **onsemi** does not convey any license under any of its intellectual property rights nor the rights of others. **onsemi** products are not designed, intended, or authorized for use as a critical component in life support systems or any FDA Class 3 medical devices or medical devices with a same or similar classification in a foreign jurisdiction or any devices intended for implantation in the human body. Should Buyer purchase or use **onsemi** products for any such unintended or unauthorized application, Buyer shall indemnify and hold **onsemi** and its officers, employees, subsidiaries, affiliates, and distributors harmless against all claims, costs, damages, and expenses, and reasonable attorney fees arising out of, directly or indirectly, any claim of personal injury or death associated with such unintended or unauthorized use, even if such claim alleges that **onsemi** was negligent regarding the design or manufacture of the part. **onsemi** is an Equal Opportunity/Affirmative Action Employer. This literature is subject to all applicable copyright laws and is not for resale in any manner.

ADDITIONAL INFORMATION

TECHNICAL PUBLICATIONS:

Technical Library: www.onsemi.com/design/resources/technical-documentation
onsemi Website: www.onsemi.com

ONLINE SUPPORT: www.onsemi.com/support

For additional information, please contact your local Sales Representative at www.onsemi.com/support/sales