

Thank you for your interest in **onsemi** products.  
Your technical document begins on the following pages.



## Your Feedback is Important to Us!

Please take a moment to participate in our short survey.  
At **onsemi**, we are dedicated to delivering technical content that best meets your needs.

### [Help Us Improve – Take the Survey](#)

This survey is intended to collect your feedback, capture any issues you may encounter, and to provide improvements you would like to suggest.

**We look forward to your feedback.**

To learn more about **onsemi**, please visit our website at  
[www.onsemi.com](http://www.onsemi.com)

**onsemi** and **onsemi** and other names, marks, and brands are registered and/or common law trademarks of Semiconductor Components Industries, LLC dba "**onsemi**" or its affiliates and/or subsidiaries in the United States and/or other countries. **onsemi** owns the rights to a number of patents, trademarks, copyrights, trade secrets, and other intellectual property. A listing of **onsemi** product/patent coverage may be accessed at [www.onsemi.com/site/pdf/Patent-Marking.pdf](http://www.onsemi.com/site/pdf/Patent-Marking.pdf). **onsemi** reserves the right to make changes at any time to any products or information herein, without notice. The information herein is provided "as-is" and **onsemi** makes no warranty, representation or guarantee regarding the accuracy of the information, product features, availability, functionality, or suitability of its products for any particular purpose, nor does **onsemi** assume any liability arising out of the application or use of any product or circuit, and specifically disclaims any and all liability, including without limitation special, consequential or incidental damages. Buyer is responsible for its products and applications using **onsemi** products, including compliance with all laws, regulations and safety requirements or standards, regardless of any support or applications information provided by **onsemi**. "Typical" parameters which may be provided in **onsemi** data sheets and/or specifications can and do vary in different applications and actual performance may vary over time. All operating parameters, including "Typicals" must be validated for each customer application by customer's technical experts. **onsemi** does not convey any license under any of its intellectual property rights nor the rights of others. **onsemi** products are not designed, intended, or authorized for use as a critical component in life support systems or any FDA Class 3 medical devices or medical devices with a same or similar classification in a foreign jurisdiction or any devices intended for implantation in the human body. Should Buyer purchase or use **onsemi** products for any such unintended or unauthorized application, Buyer shall indemnify and hold **onsemi** and its officers, employees, subsidiaries, affiliates, and distributors harmless against all claims, costs, damages, and expenses, and reasonable attorney fees arising out of, directly or indirectly, any claim of personal injury or death associated with such unintended or unauthorized use, even if such claim alleges that **onsemi** was negligent regarding the design or manufacture of the part. **onsemi** is an Equal Opportunity/Affirmative Action Employer. This literature is subject to all applicable copyright laws and is not for resale in any manner. Other names and brands may be claimed as the property of others.

# Power Rectifier, Ultra-Fast Recovery, 1 A, 50-600 V

## ULTRAFAST RECTIFIERS 1.0 AMPERE, 50-600 VOLTS

**MURS105, MURS110,  
 MURS115, MURS120,  
 MURS140, MURS160,  
 SURS8105, SURS8110,  
 SURS8120, SURS8140,  
 SURS8160, NRVUS110V,  
 NRVUS120V, NRVUS160V**

Ideally suited for high voltage, high frequency rectification, or as free wheeling and protection diodes in surface mount applications where compact size and weight are critical to the system.

### Features

- Small Compact Surface Mountable Package with J-Bend Leads
- Rectangular Package for Automated Handling
- High Temperature Glass Passivated Junction
- Low Forward Voltage Drop (0.71 to 1.05 V Max @ 1.0 A, T<sub>J</sub> = 150°C)
- NRVUS and SURS8 Prefixes for Automotive and Other Applications Requiring Unique Site and Control Change Requirements; AEC-Q101 Qualified and PPAP Capable
- These Devices are Pb-Free and are RoHS Compliant

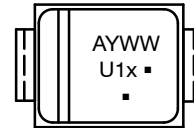
### Mechanical Characteristics:

- Case: Epoxy, Molded
- Weight: 95 mg (Approximately)
- Finish: All External Surfaces Corrosion Resistant and Terminal Leads are Readily Solderable
- Lead and Mounting Surface Temperature for Soldering Purposes: 260°C Max. for 10 Seconds
- Polarity: Polarity Band Indicates Cathode Lead
- ESD Rating:
  - ◆ Human Body Model = 3B (> 8 kV)
  - ◆ Charged Device Model > 1000 V



SMB  
 CASE 403A

### MARKING DIAGRAM



- A = Assembly Location\*
- Y = Year
- WW = Work Week
- U1 = Device Code
  - x = A, B, C, D, G, or J
  - = Pb-Free Package

(Note: Microdot may be in either location)

\* The Assembly Location code (A) is front side optional. In cases where the Assembly Location is stamped in the package bottom (molding ejector pin), the front side assembly code may be blank.

### ORDERING INFORMATION

See detailed ordering and shipping information in the table on page 2 of this data sheet.

### DEVICE MARKING INFORMATION

See general marking information in the device marking table on page 2 of this data sheet.

# MURS105, MURS110, MURS115, MURS120, MURS140, MURS160, SURS8105, SURS8110, SURS8120, SURS8140, SURS8160, NRVS110V, NRVS120V, NRVS160V

## MAXIMUM RATINGS

Rating	Symbol	MURS/SURS8/NRVS						Unit
		105T3	110T3	115T3	120T3	140T3	160T3	
Peak Repetitive Reverse Voltage Working Peak Reverse Voltage DC Blocking Voltage	$V_{RRM}$ $V_{RWM}$ $V_R$	50	100	150	200	400	600	V
Continuous Forward Current	$I_{F(DC)}$	1.0 @ $T_L = 159^\circ\text{C}$ 2.0 @ $T_L = 139^\circ\text{C}$			1.0 @ $T_L = 159^\circ\text{C}$ 2.0 @ $T_L = 139^\circ\text{C}$			A
Non-Repetitive Peak Surge Current, (Surge applied at rated load conditions halfwave, single phase, 60 Hz)	$I_{FSM}$	35			35			A
Operating Junction Temperature	$T_J$	-65 to +175						$^\circ\text{C}$

Stresses exceeding those listed in the Maximum Ratings table may damage the device. If any of these limits are exceeded, device functionality should not be assumed, damage may occur and reliability may be affected.

## THERMAL CHARACTERISTICS

Rating	Symbol	MURS/SURS8/NRVS						Unit
		105T3	110T3	115T3	120T3	140T3	160T3	
Thermal Resistance Junction-to-Lead ( $T_L = 25^\circ\text{C}$ )	$R_{\theta JL}$	13						$^\circ\text{C}/\text{W}$

## ELECTRICAL CHARACTERISTICS ( $T_A = 25^\circ\text{C}$ , Unless otherwise noted)

Maximum Instantaneous Forward Voltage (Note 1) ( $i_F = 1.0\text{ A}$ , $T_J = 25^\circ\text{C}$ ) ( $i_F = 1.0\text{ A}$ , $T_J = 150^\circ\text{C}$ )	$v_F$	0.875 0.71			1.25 1.05		V
Maximum Instantaneous Reverse Current (Note 1) (Rated DC Voltage, $T_J = 25^\circ\text{C}$ ) (Rated DC Voltage, $T_J = 150^\circ\text{C}$ )	$i_R$	2.0 50			5.0 150		$\mu\text{A}$
Maximum Reverse Recovery Time ( $i_F = 1.0\text{ A}$ , $di/dt = 50\text{ A}/\mu\text{s}$ , $V_R = 30\text{ V}$ ) ( $i_F = 0.5\text{ A}$ , $i_R = 1.0\text{ A}$ , $I_R$ to 0.25 A)	$t_{rr}$	35 25			75 50		ns
Maximum Forward Recovery Time ( $i_F = 1.0\text{ A}$ , $di/dt = 100\text{ A}/\mu\text{s}$ , Rec. to 1.0 V)	$t_{fr}$	25			50		ns
Typical Peak Reverse Recovery Current ( $i_F = 1.0\text{ A}$ , $di/dt = 50\text{ A}/\mu\text{s}$ )	$I_{RM}$	0.75			1.60		A

1. Pulse Test: Pulse Width = 300  $\mu\text{s}$ , Duty Cycle  $\leq 2.0\%$ .

## DEVICE MARKING AND ORDERING INFORMATION

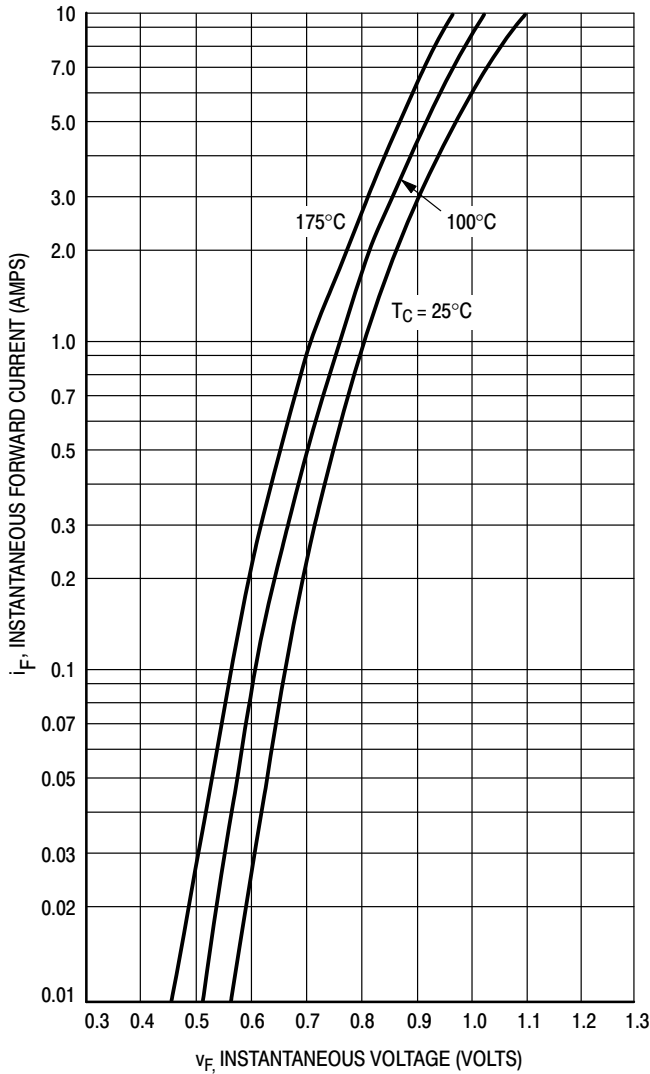
Device	Marking	Package	Shipping <sup>†</sup>
MURS105T3G, SURS8105T3G*	U1A	SMB (Pb-Free)	2,500 Units / Tape & Reel
MURS110T3G, NRVS110VT3G*, NRVS110VT3G-GA01*, SURS8110T3G*	U1B	SMB (Pb-Free)	2,500 Units / Tape & Reel
MURS115T3G, SURS8115T3G*	U1C	SMB (Pb-Free)	2,500 Units / Tape & Reel
MURS120T3G, NRVS120VT3G*, NRVS120VT3G-GA01*, SURS8120T3G*	U1D	SMB (Pb-Free)	2,500 Units / Tape & Reel
MURS140T3G, SURS8140T3G*	U1G	SMB (Pb-Free)	2,500 Units / Tape & Reel
MURS160T3G, NRVS160VT3G*, NRVS160VT3G-GA01*, SURS8160T3G*	U1J	SMB (Pb-Free)	2,500 Units / Tape & Reel

<sup>†</sup>For information on tape and reel specifications, including part orientation and tape sizes, please refer to our Tape and Reel Packaging Specifications Brochure, BRD8011/D.

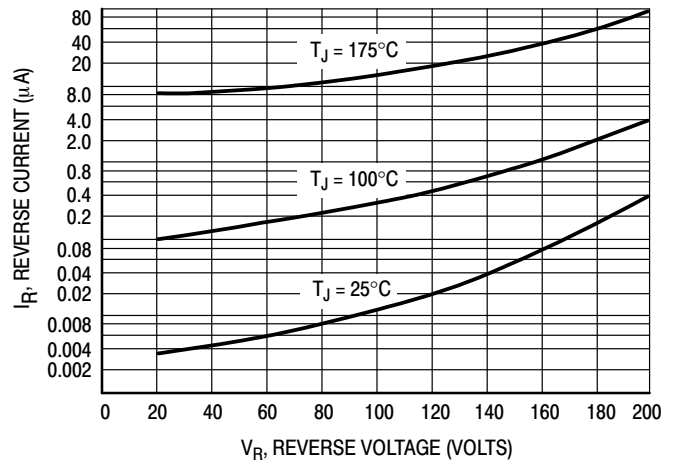
\*NRVS and SURS8 Prefixes for Automotive and Other Applications Requiring Unique Site and Control Change Requirements; AEC-Q101 Qualified and PPAP Capable.

**MURS105, MURS110, MURS115, MURS120, MURS140, MURS160, SURS8105, SURS8110, SURS8120, SURS8140, SURS8160, NRVUS110V, NRVUS120V, NRVUS160V**

**MURS105T3G, MURS110T3G, MURS115T3G, MURS120T3G, SURS8105T3G, SURS8110T3G, SURS8115T3G, SURS8120T3G, NRVUS110VT3G, NRVUS120VT3G, NRVUS110VT3G-GA01, NRVUS120VT3G-GA01**

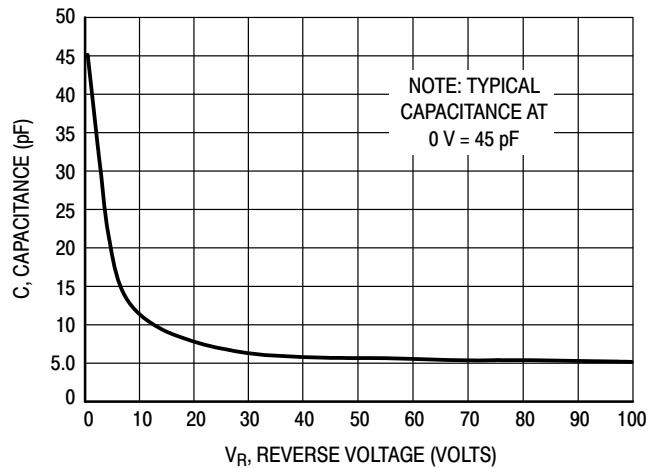


**Figure 1. Typical Forward Voltage**

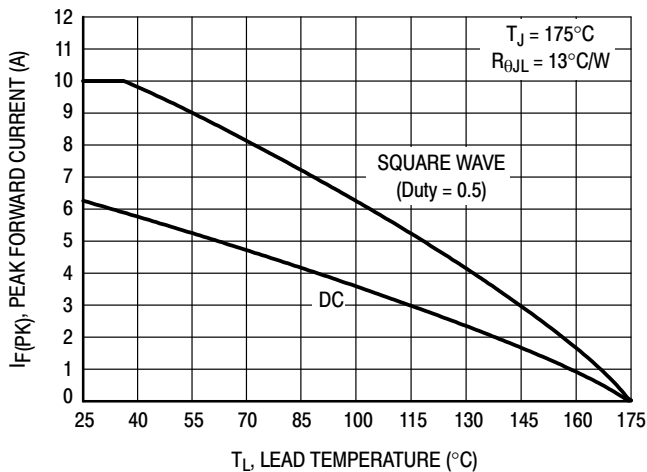


**Figure 2. Typical Reverse Current\***

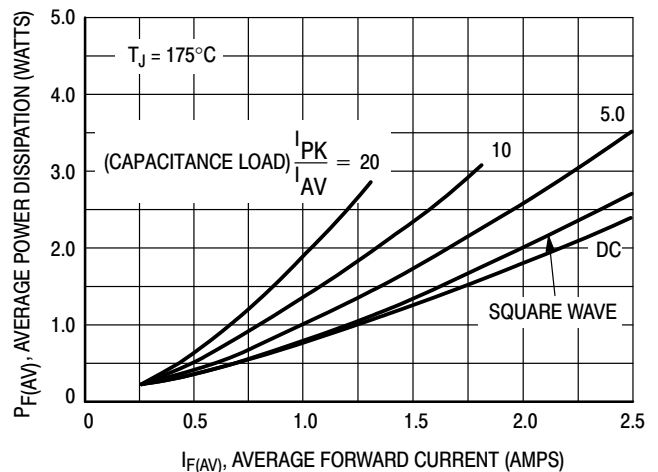
\*The curves shown are typical for the highest voltage device in the voltage grouping. Typical reverse current for lower voltage selections can be estimated from these same curves if applied  $V_R$  is sufficiently below rated  $V_R$ .



**Figure 3. Typical Capacitance**

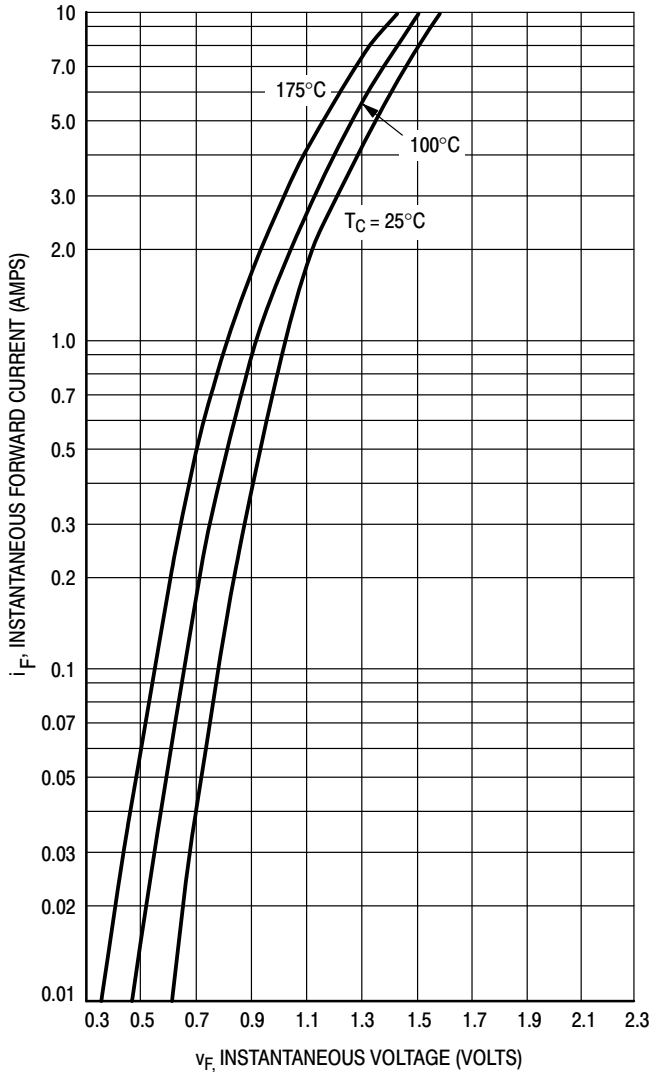


**Figure 4. Forward Current Derating of Lead Temperature**

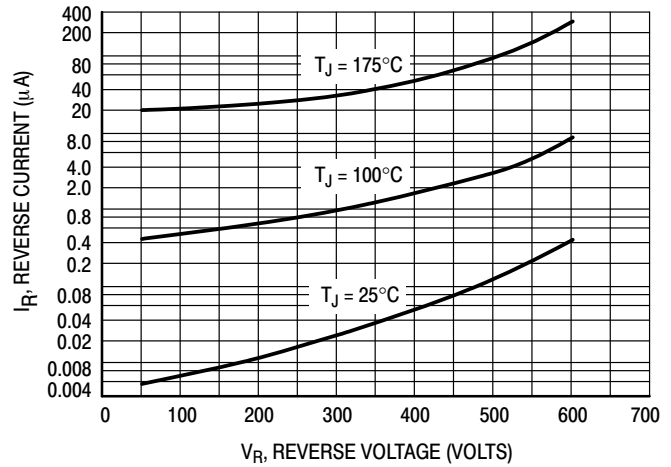


**Figure 5. Power Dissipation**

**MURS105, MURS110, MURS115, MURS120, MURS140, MURS160, SURS8105, SURS8110, SURS8120, SURS8140, SURS8160, NRVUS110V, NRVUS120V, NRVUS160V MURS140T3G, MURS160T3G, SURS8140T3G, SURS8160T3G, NRVUS160VT3G, NRVUS160VT3G-GA01**

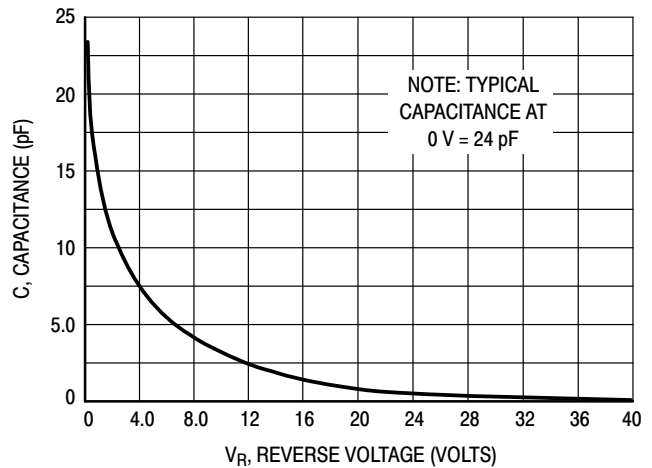


**Figure 6. Typical Forward Voltage**

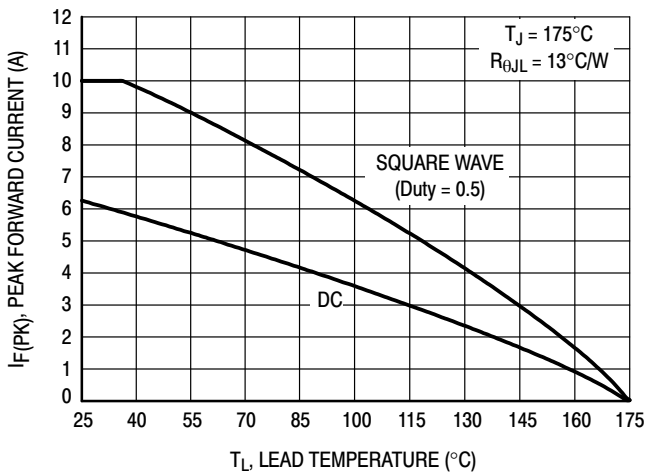


**Figure 7. Typical Reverse Current\***

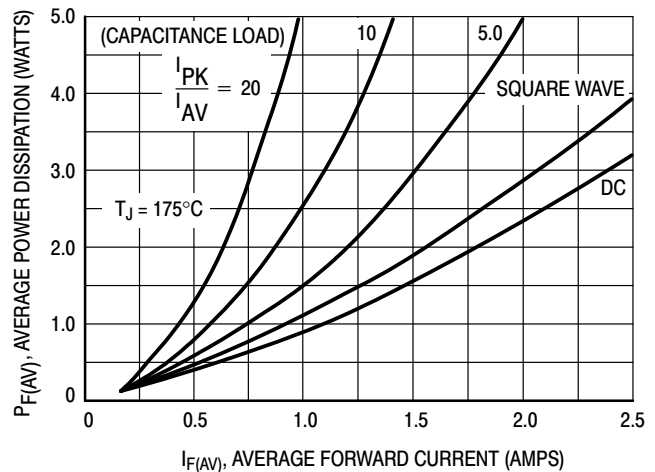
\*The curves shown are typical for the highest voltage device in the voltage grouping. Typical reverse current for lower voltage selections can be estimated from these same curves if applied  $V_R$  is sufficiently below rated  $V_R$ .



**Figure 8. Typical Capacitance**



**Figure 9. Forward Current Derating of Lead Temperature**



**Figure 10. Power Dissipation**

# MECHANICAL CASE OUTLINE

## PACKAGE DIMENSIONS

ON Semiconductor®



SCALE 1:1

Polarity Band

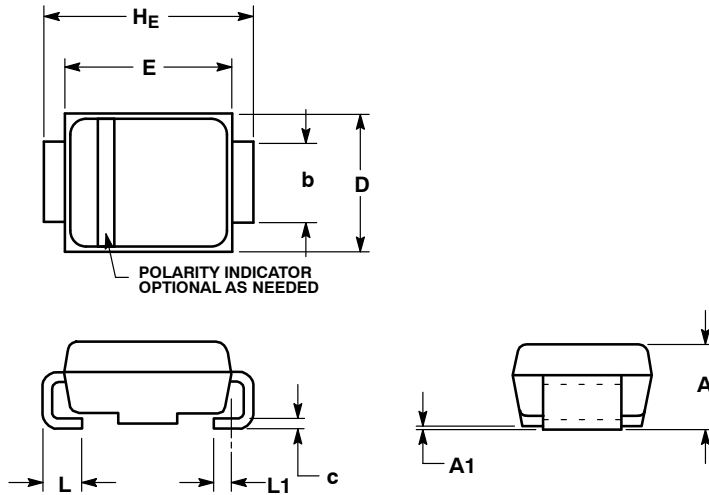


SCALE 1:1

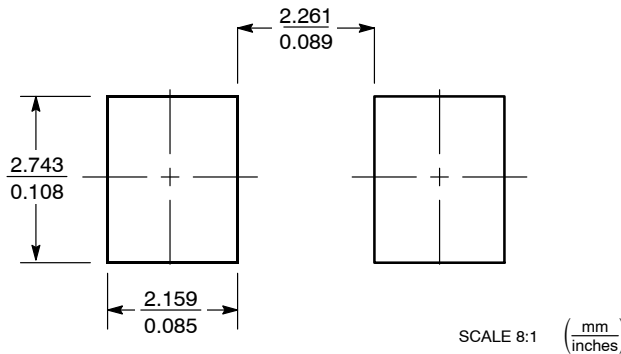
Non-Polarity Band

**SMB**  
CASE 403A-03  
ISSUE J

DATE 19 JUL 2012



**SOLDERING FOOTPRINT\***

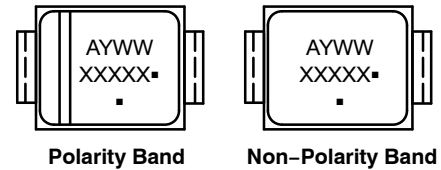


\*For additional information on our Pb-Free strategy and soldering details, please download the ON Semiconductor Soldering and Mounting Techniques Reference Manual, SOLDERRM/D.

- NOTES:
1. DIMENSIONING AND TOLERANCING PER ANSI Y14.5M, 1982.
  2. CONTROLLING DIMENSION: INCH.
  3. DIMENSION b SHALL BE MEASURED WITHIN DIMENSION L1.

DIM	MILLIMETERS			INCHES		
	MIN	NOM	MAX	MIN	NOM	MAX
A	1.95	2.30	2.47	0.077	0.091	0.097
A1	0.05	0.10	0.20	0.002	0.004	0.008
b	1.96	2.03	2.20	0.077	0.080	0.087
c	0.15	0.23	0.31	0.006	0.009	0.012
D	3.30	3.56	3.95	0.130	0.140	0.156
E	4.06	4.32	4.60	0.160	0.170	0.181
HE	5.21	5.44	5.60	0.205	0.214	0.220
L	0.76	1.02	1.60	0.030	0.040	0.063
L1	0.51 REF			0.020 REF		

**GENERIC MARKING DIAGRAM\***



- XXXXX = Specific Device Code
  - A = Assembly Location
  - Y = Year
  - WW = Work Week
  - = Pb-Free Package
- (Note: Microdot may be in either location)

\*This information is generic. Please refer to device data sheet for actual part marking. Pb-Free indicator, "G" or microdot "▪", may or may not be present.

<b>DOCUMENT NUMBER:</b>	<b>98ASB42669B</b>	Electronic versions are uncontrolled except when accessed directly from the Document Repository. Printed versions are uncontrolled except when stamped "CONTROLLED COPY" in red.
<b>DESCRIPTION:</b>	<b>SMB</b>	<b>PAGE 1 OF 1</b>

ON Semiconductor and ON are trademarks of Semiconductor Components Industries, LLC dba ON Semiconductor or its subsidiaries in the United States and/or other countries. ON Semiconductor reserves the right to make changes without further notice to any products herein. ON Semiconductor makes no warranty, representation or guarantee regarding the suitability of its products for any particular purpose, nor does ON Semiconductor assume any liability arising out of the application or use of any product or circuit, and specifically disclaims any and all liability, including without limitation special, consequential or incidental damages. ON Semiconductor does not convey any license under its patent rights nor the rights of others.

**onsemi**, **Onsemi**, and other names, marks, and brands are registered and/or common law trademarks of Semiconductor Components Industries, LLC dba "**onsemi**" or its affiliates and/or subsidiaries in the United States and/or other countries. **onsemi** owns the rights to a number of patents, trademarks, copyrights, trade secrets, and other intellectual property. A listing of **onsemi**'s product/patent coverage may be accessed at [www.onsemi.com/site/pdf/Patent-Marking.pdf](http://www.onsemi.com/site/pdf/Patent-Marking.pdf). **onsemi** reserves the right to make changes at any time to any products or information herein, without notice. The information herein is provided "as-is" and **onsemi** makes no warranty, representation or guarantee regarding the accuracy of the information, product features, availability, functionality, or suitability of its products for any particular purpose, nor does **onsemi** assume any liability arising out of the application or use of any product or circuit, and specifically disclaims any and all liability, including without limitation special, consequential or incidental damages. Buyer is responsible for its products and applications using **onsemi** products, including compliance with all laws, regulations and safety requirements or standards, regardless of any support or applications information provided by **onsemi**. "Typical" parameters which may be provided in **onsemi** data sheets and/or specifications can and do vary in different applications and actual performance may vary over time. All operating parameters, including "Typicals" must be validated for each customer application by customer's technical experts. **onsemi** does not convey any license under any of its intellectual property rights nor the rights of others. **onsemi** products are not designed, intended, or authorized for use as a critical component in life support systems or any FDA Class 3 medical devices or medical devices with a same or similar classification in a foreign jurisdiction or any devices intended for implantation in the human body. Should Buyer purchase or use **onsemi** products for any such unintended or unauthorized application, Buyer shall indemnify and hold **onsemi** and its officers, employees, subsidiaries, affiliates, and distributors harmless against all claims, costs, damages, and expenses, and reasonable attorney fees arising out of, directly or indirectly, any claim of personal injury or death associated with such unintended or unauthorized use, even if such claim alleges that **onsemi** was negligent regarding the design or manufacture of the part. **onsemi** is an Equal Opportunity/Affirmative Action Employer. This literature is subject to all applicable copyright laws and is not for resale in any manner.

## ADDITIONAL INFORMATION

### TECHNICAL PUBLICATIONS:

Technical Library: [www.onsemi.com/design/resources/technical-documentation](http://www.onsemi.com/design/resources/technical-documentation)  
onsemi Website: [www.onsemi.com](http://www.onsemi.com)

### ONLINE SUPPORT: [www.onsemi.com/support](http://www.onsemi.com/support)

For additional information, please contact your local Sales Representative at [www.onsemi.com/support/sales](http://www.onsemi.com/support/sales)