

ESD Protection Diode

Ultra-Low Capacitance

Micro-Packaged Diodes for ESD Protection

ESD7410

The ESD7410 is designed to protect voltage sensitive components that require ultra-low capacitance from ESD and transient voltage events. It has industry leading capacitance linearity over voltage making it ideal for RF applications. This capacitance linearity combined with the extremely small package and low insertion loss makes this part well suited for use in antenna line applications for wireless handsets and terminals.

Features

- Ultra-Low Capacitance: < 1.0 pF Max
 - ◆ Industry Leading Capacitance Linearity Over Voltage
- Insertion Loss: 0.1 dB at 1 GHz; 0.3 dB at 3 GHz
- Low Leakage: < 1 μ A
- IEC61000-4-2 (ESD): Level 4 \pm 30 kV Contact
- ISO 10605 (ESD) 330 pF/2 k Ω \pm 30 kV Contact
- SZESD7410MXWT5G – Wettable Flank Package for optimal Automated Optical Inspection (AOI)
- SZ Prefix for Automotive and Other Applications Requiring Unique Site and Control Change Requirements; AEC-Q101 Qualified and PPAP Capable
- These Devices are Pb-Free, Halogen Free/BFR Free and are RoHS Compliant

Typical Applications

- RF Signal ESD Protection
- Active Antenna ESD Protection
- Near Field Communications

MAXIMUM RATINGS (T_A = 25°C unless otherwise noted)

Rating	Symbol	Value	Unit
Total Power Dissipation (Note 2) @ T _A = 25°C Thermal Resistance, Junction-to-Ambient	P _D R _{θJA}	300 400	mW °C/W
Peak Power Dissipation 8/20 Double Exponential Waveform	P _{PK}	136	W
Junction and Storage Temperature Range	T _J , T _{stg}	-55 to +150	°C
Lead Solder Temperature – Maximum (10 Second Duration)	T _L	260	°C
Maximum Peak Pulse Current 8/20	I _{PP}	6.4	A
IEC 61000-4-2 Contact (Note 1)	ESD	\pm 30	kV
IEC 61000-4-2 Air		\pm 30	kV
ISO 10605 Contact (330 pF / 330 Ω)		\pm 30	kV
ISO 10605 Contact (330 pF / 2 k Ω)		\pm 30	kV
ISO 10605 Contact (150 pF / 2 k Ω)		\pm 30	kV
Human Body Model (HBM)		\pm 8	kV

Stresses exceeding those listed in the Maximum Ratings table may damage the device. If any of these limits are exceeded, device functionality should not be assumed, damage may occur and reliability may be affected.

1. Non-repetitive current pulse at T_A = 25°C, per IEC61000-4-2 waveform.
2. Mounted with recommended minimum pad size, DC board FR-4



MARKING DIAGRAM



X2DFN2
CASE 714AB

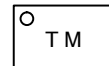

T = Specific Device Code
M = Date Code



X2DFNW2
CASE 711BG



D = Specific Device Code
M = Date Code

ORDERING INFORMATION

Device	Package	Shipping [†]
ESD7410N2T5G	X2DFN2 (Pb-Free)	8000 / Tape & Reel
SZESD7410N2T5G	X2DFN2 (Pb-Free)	8000 / Tape & Reel
ESD7410MXWT5G	X2DFNW2 (Pb-Free)	8000 / Tape & Reel
SZESD7410MXWT5G	X2DFNW2 (Pb-Free)	8000 / Tape & Reel

[†]For information on tape and reel specifications, including part orientation and tape sizes, please refer to our Tape and Reel Packaging Specifications Brochure, BRD8011/D.

ESD7410

ELECTRICAL CHARACTERISTICS

($T_A = 25^\circ\text{C}$ unless otherwise noted)

Symbol	Parameter
I_{PP}	Maximum Reverse Peak Pulse Current
V_C	Clamping Voltage @ I_{PP}
V_{RWM}	Working Peak Reverse Voltage
I_R	Maximum Reverse Leakage Current @ V_{RWM}
V_{BR}	Breakdown Voltage @ I_T
I_T	Test Current

*See Application Note AND8308/D for detailed explanations of datasheet parameters.

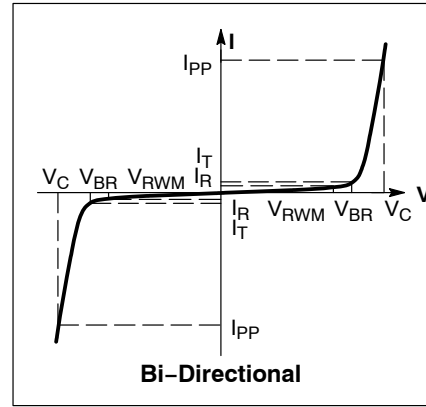

ELECTRICAL CHARACTERISTICS ($T_A = 25^\circ\text{C}$ unless otherwise noted)

Symbol	Parameter	Condition	Min	Typ	Max	Unit
V_{RWM}	Reverse Working Voltage				9.5	V
V_{BR}	Breakdown Voltage	$I_T = 1 \text{ mA}$ (Note 3)	10			V
I_R	Reverse Leakage Current	$V_{RWM} = 9.5 \text{ V}$			1.0	μA
V_C	Clamping Voltage	IEC 61000-4-2, $\pm 8 \text{ kV}$ Contact	See Figures 7 and 8			V
V_C	Clamping Voltage, TLP (Note 4)	$I_{PP} = 8 \text{ A}$ $I_{PP} = 16 \text{ A}$ $I_{PP} = -8 \text{ A}$ $I_{PP} = -16 \text{ A}$		18 20 -18 -20		V
I_{PP}	Reverse Peak Pulse Current	IEC 61000-4-2 (8/20 μs)	5.0			A
V_C	Clamping Voltage (8/20 μs)	$I_{PP} = 5.0 \text{ A}$		18.4	19.4	V
R_{DYN}	Dynamic Resistance	TLP Pulse		1.0		Ω
C_J	Junction Capacitance	$V_R = 0 \text{ V}$, $f = 1 \text{ MHz}$ $V_R = 0 \text{ V}$, $f = 1 \text{ GHz}$		0.40 0.35	1.0 0.7	pF
	Insertion Loss	$f = 1 \text{ GHz}$ $f = 3 \text{ GHz}$		0.1 0.3		dB

Product parametric performance is indicated in the Electrical Characteristics for the listed test conditions, unless otherwise noted. Product performance may not be indicated by the Electrical Characteristics if operated under different conditions.

3. Breakdown voltage is tested from pin 1 to 2 and pin 2 to 1.

4. ANSI/ESD STM5.5.1 – Electrostatic Discharge Sensitivity Testing using Transmission Line Pulse (TLP) Model.

TLP conditions: $Z_0 = 50 \Omega$, $t_p = 100 \text{ ns}$, $t_r = 4 \text{ ns}$, averaging window; $t_1 = 30 \text{ ns}$ to $t_2 = 60 \text{ ns}$.

ESD7410

TYPICAL CHARACTERISTICS

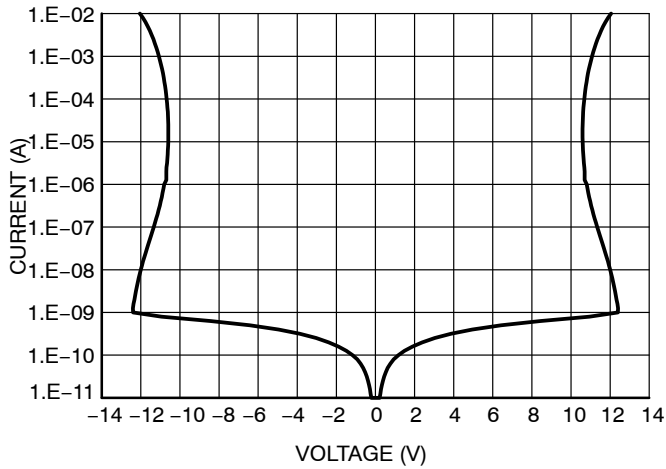

Figure 1. Typical IV Characteristics

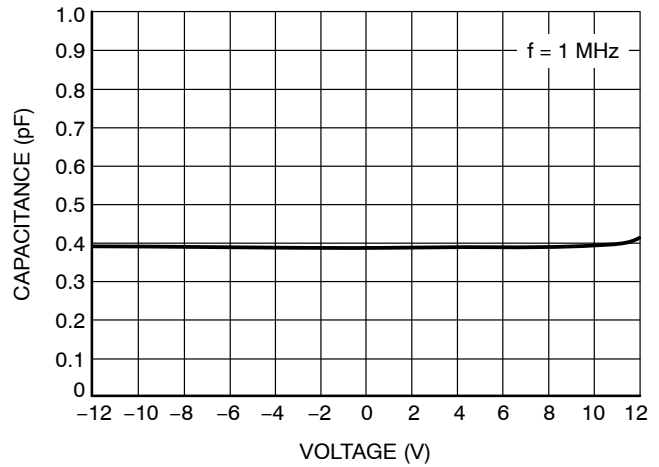

Figure 2. Typical CV Characteristics

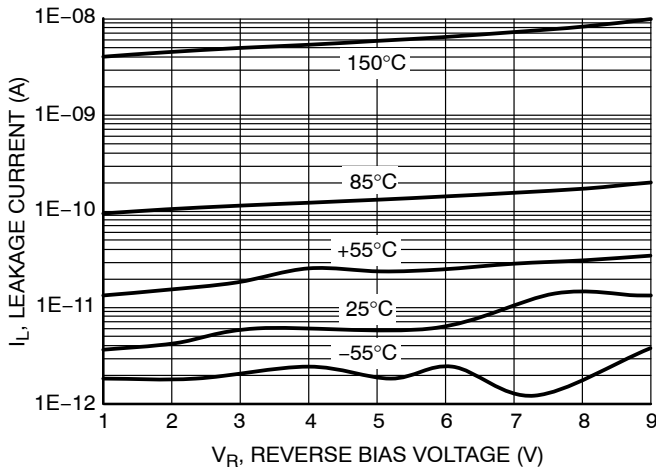

Figure 3. I_R vs. Temperature Characteristics

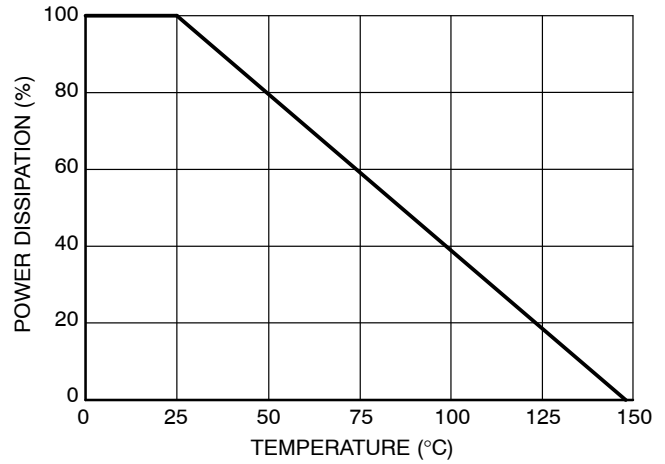

Figure 4. Steady State Power Derating

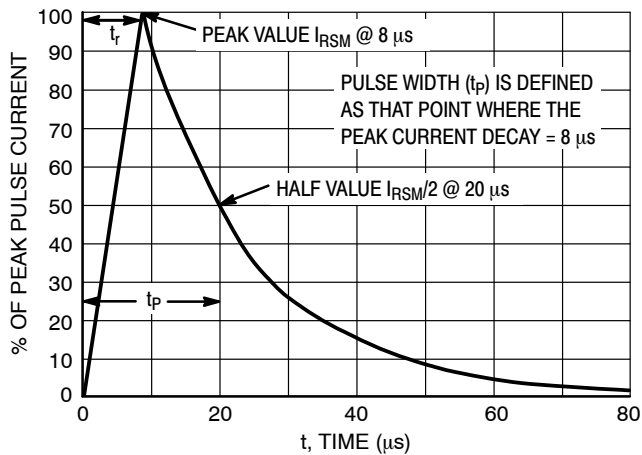

Figure 5. 8 X 20 μ s Pulse Waveform

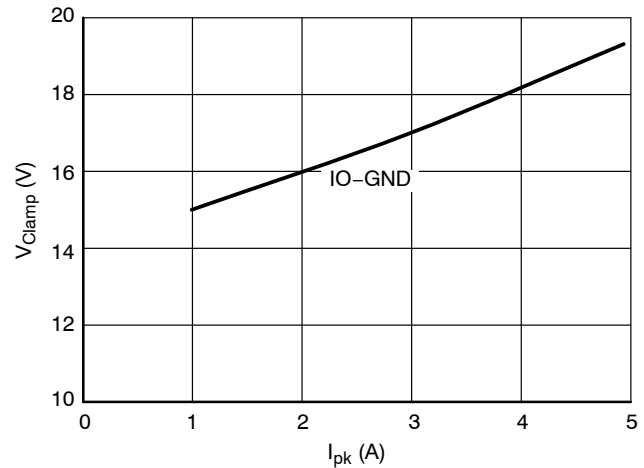

Figure 6. Clamping Voltage vs. Peak Pulse Current (8/20 μ s)

ESD7410

TYPICAL CHARACTERISTICS

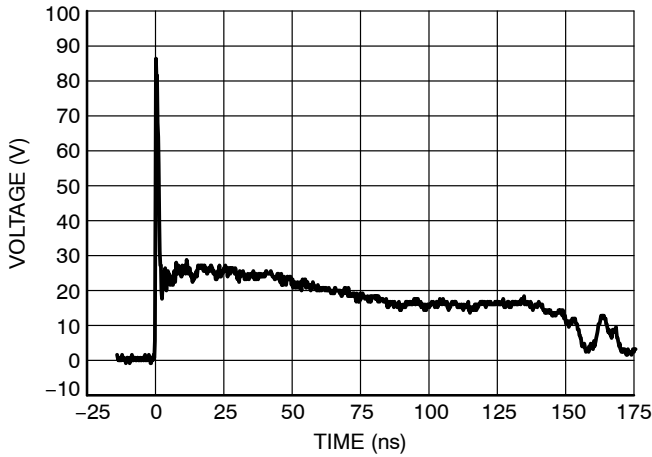

Figure 7. Typical IEC61000-4-2 +8 kV Contact ESD Clamping Voltage

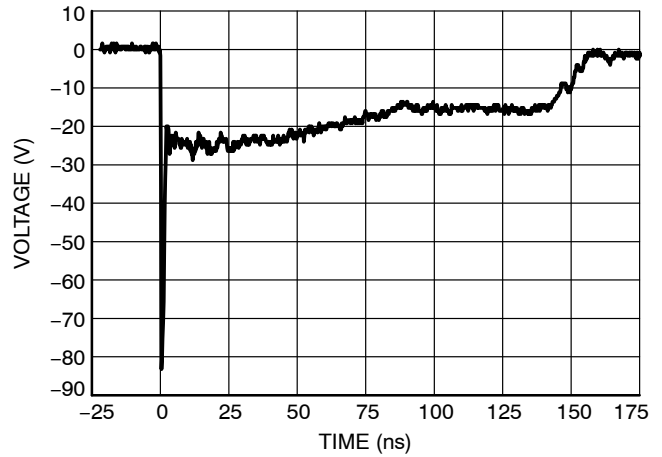

Figure 8. Typical IEC61000-4-2 -8 kV Contact ESD Clamping Voltage

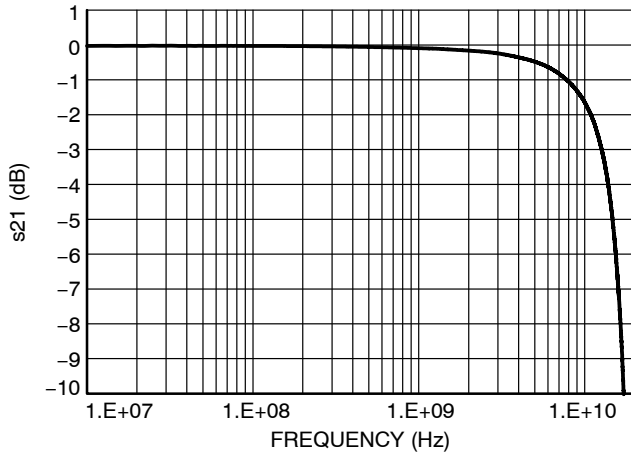

Figure 9. Typical Insertion Loss ESD7410N2T5G

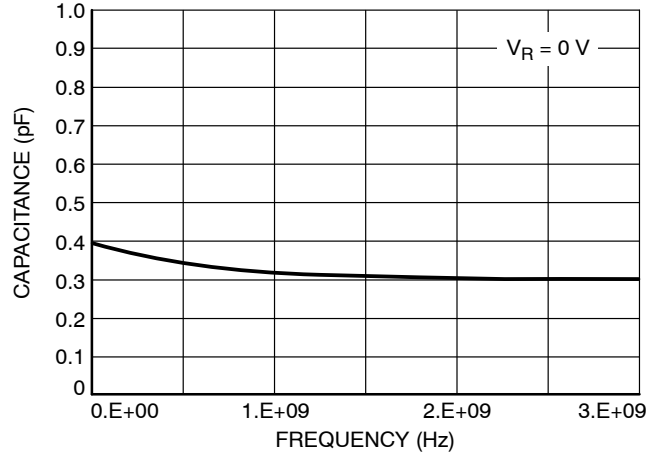

Figure 10. Typical Capacitance over Frequency ESD7410N2T5G

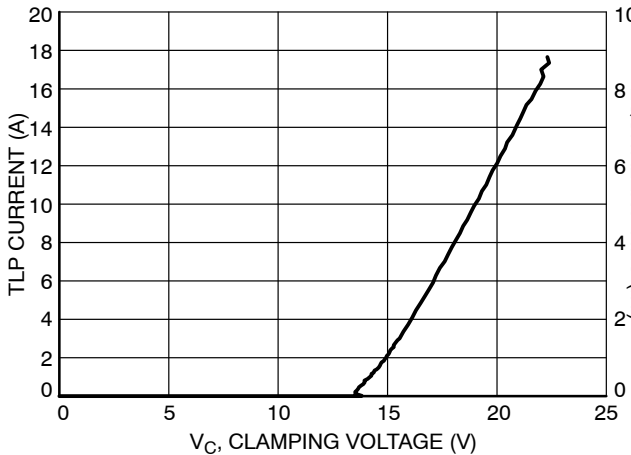

Figure 11. Positive TLP I-V Curve

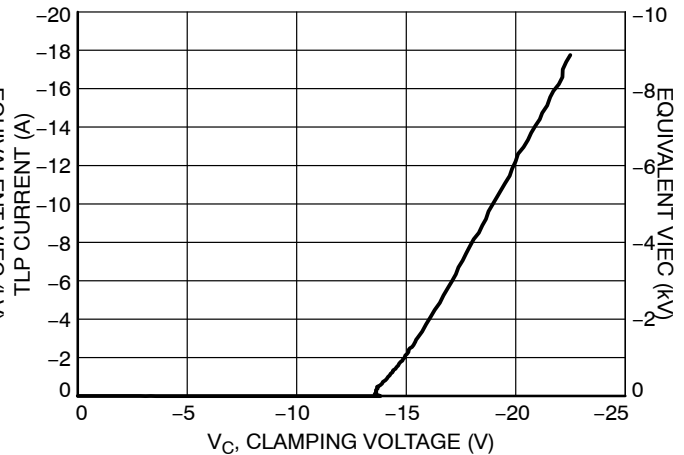

Figure 12. Negative TLP I-V Curve

NOTE: TLP parameter: $Z_0 = 50 \Omega$, $t_p = 100 \text{ ns}$, $t_r = 300 \text{ ps}$, averaging window: $t_1 = 30 \text{ ns}$ to $t_2 = 60 \text{ ns}$. V_{IEC} is the equivalent voltage stress level calculated at the secondary peak of the IEC 61000-4-2 waveform at $t = 30 \text{ ns}$ with 2 A/kV . See TLP description below for more information.

ESD7410

IEC 61000-4-2 Spec.

Level	Test Voltage (kV)	First Peak Current (A)	Current at 30 ns (A)	Current at 60 ns (A)
1	2	7.5	4	2
2	4	15	8	4
3	6	22.5	12	6
4	8	30	16	8



Figure 13. IEC61000-4-2 Spec

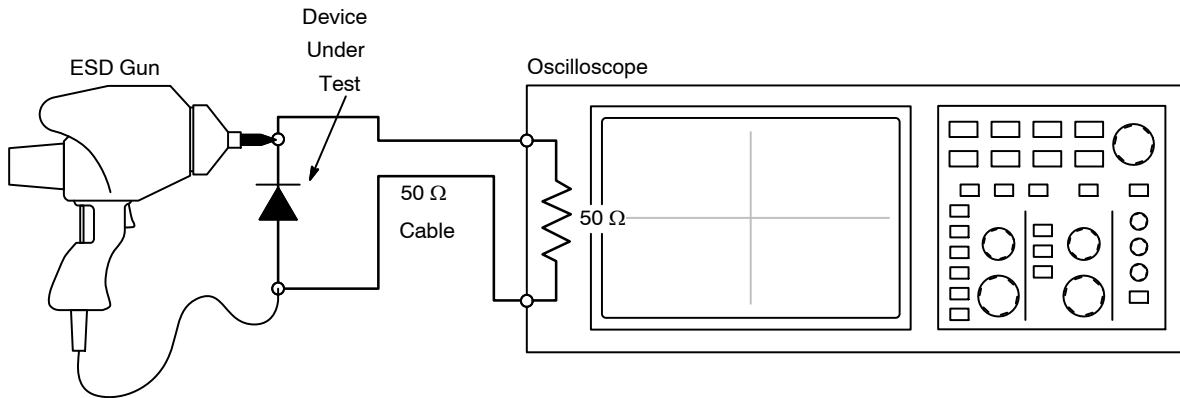

Figure 14. Diagram of ESD Clamping Voltage Test Setup

The following is taken from Application Note AND8308/D – Interpretation of Datasheet Parameters for ESD Devices.

ESD Voltage Clamping

For sensitive circuit elements it is important to limit the voltage that an IC will be exposed to during an ESD event to as low a voltage as possible. The ESD clamping voltage is the voltage drop across the ESD protection diode during an ESD event per the IEC61000-4-2 waveform. Since the IEC61000-4-2 was written as a pass/fail spec for larger

systems such as cell phones or laptop computers it is not clearly defined in the spec how to specify a clamping voltage at the device level. ON Semiconductor has developed a way to examine the entire voltage waveform across the ESD protection diode over the time domain of an ESD pulse in the form of an oscilloscope screenshot, which can be found on the datasheets for all ESD protection diodes. For more information on how ON Semiconductor creates these screenshots and how to interpret them please refer to AND8307/D.

Transmission Line Pulse (TLP) Measurement

Transmission Line Pulse (TLP) provides current versus voltage (I-V) curves in which each data point is obtained from a 100 ns long rectangular pulse from a charged transmission line. A simplified schematic of a typical TLP system is shown in Figure 15. TLP I-V curves of ESD protection devices accurately demonstrate the product’s ESD capability because the 10s of amps current levels and under 100 ns time scale match those of an ESD event. This is illustrated in Figure 16 where an 8 kV IEC 61000-4-2 current waveform is compared with TLP current pulses at 8 A and 16 A. A TLP I-V curve shows the voltage at which the device turns on as well as how well the device clamps voltage over a range of current levels.

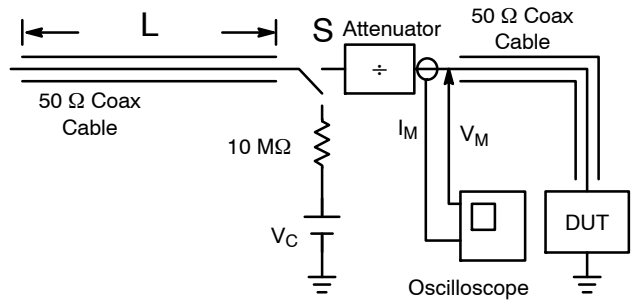

Figure 15. Simplified Schematic of a Typical TLP System

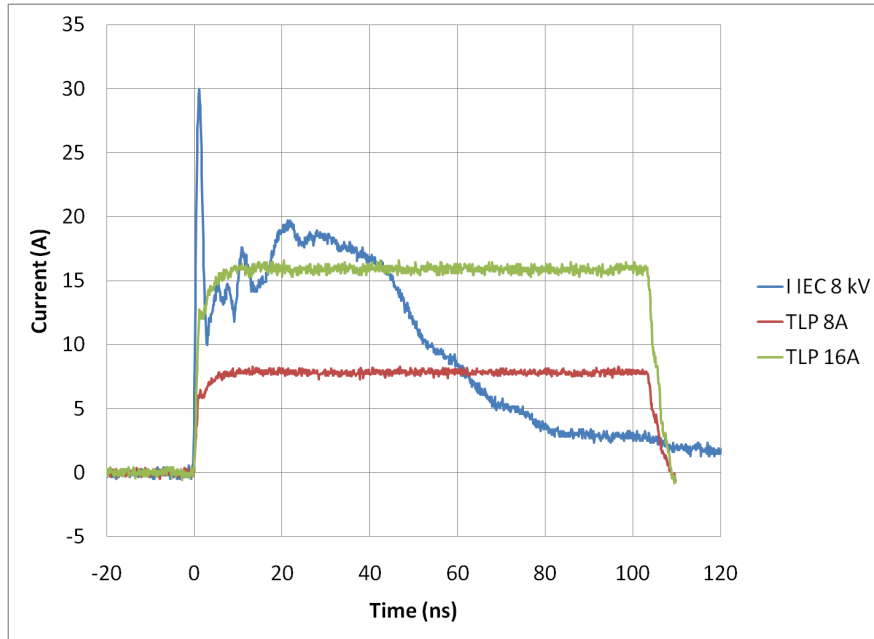
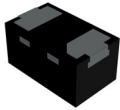

Figure 16. Comparison Between 8 kV IEC 61000-4-2 and 8 A and 16 A TLP Waveforms

MECHANICAL CASE OUTLINE PACKAGE DIMENSIONS



X2DFNW2 1.00x0.60x0.37, 0.65P
CASE 711BG
ISSUE D

DATE 29 FEB 2024

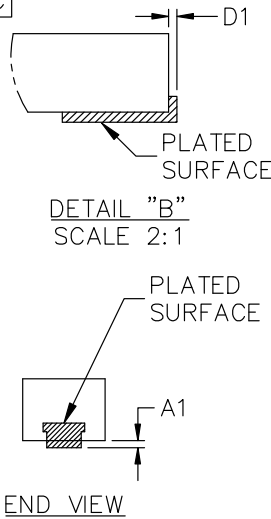
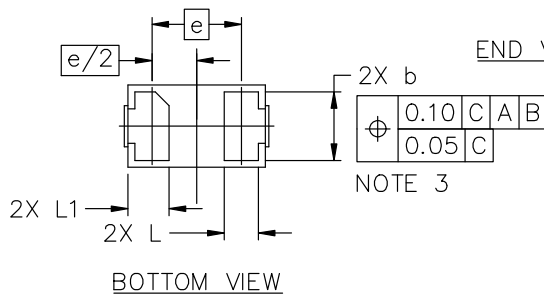
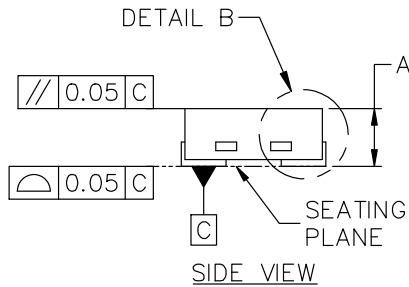
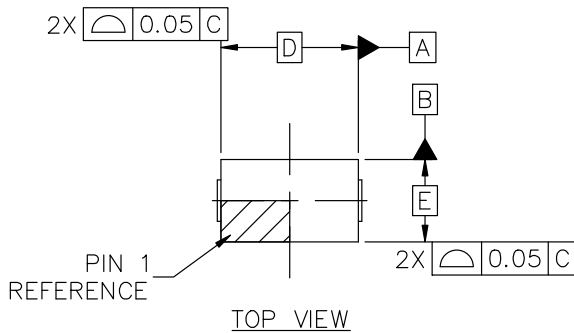

DIM	MILLIMETERS		
	MIN.	NOM.	MAX.
A	0.34	0.37	0.40
A1	---	---	0.05
b	0.45	0.50	0.55
D	1.00 BSC		
D1	---	---	0.05
E	0.60 BSC		
e	0.65 BSC		
L	0.22 REF		
L1	0.24	0.28	0.34

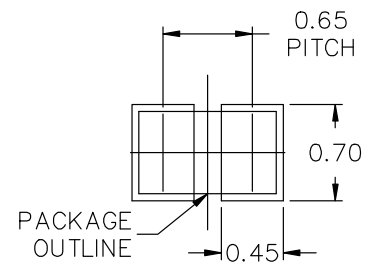

RECOMMENDED MOUNTING FOOTPRINT*

* FOR ADDITIONAL INFORMATION ON OUR Pb-FREE STRATEGY AND SOLDERING DETAILS, PLEASE DOWNLOAD THE ON SEMICONDUCTOR SOLDERING AND MOUNTING TECHNIQUES REFERENCE MANUAL, SOLDERRM/D.

GENERIC MARKING DIAGRAM*



XX = Specific Device Code
M = Date Code

*This information is generic. Please refer to device data sheet for actual part marking. Pb-Free indicator, "G", may or not be present. Some products may not follow the Generic Marking.

DOCUMENT NUMBER:	98AON15241G	Electronic versions are uncontrolled except when accessed directly from the Document Repository. Printed versions are uncontrolled except when stamped "CONTROLLED COPY" in red.
DESCRIPTION:	X2DFNW2 1.00x0.60x0.37, 0.65P	PAGE 1 OF 1

onsemi and ONSEMI are trademarks of Semiconductor Components Industries, LLC dba onsemi or its subsidiaries in the United States and/or other countries. onsemi reserves the right to make changes without further notice to any products herein. onsemi makes no warranty, representation or guarantee regarding the suitability of its products for any particular purpose, nor does onsemi assume any liability arising out of the application or use of any product or circuit, and specifically disclaims any and all liability, including without limitation special, consequential or incidental damages. onsemi does not convey any license under its patent rights nor the rights of others.

MECHANICAL CASE OUTLINE

PACKAGE DIMENSIONS

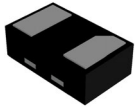

X2DFN2 1.00x0.60x0.37, 0.65P
CASE 714AB
ISSUE C

DATE 21 FEB 2024

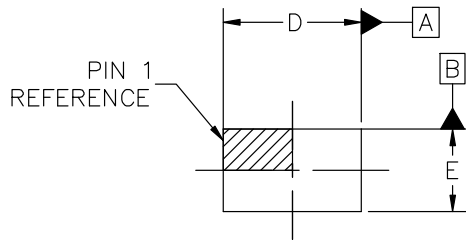

TOP VIEW

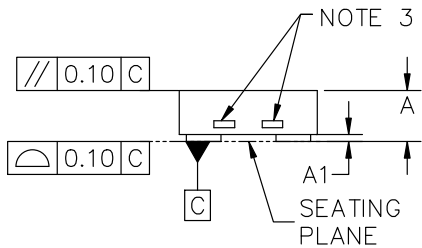

SIDE VIEW

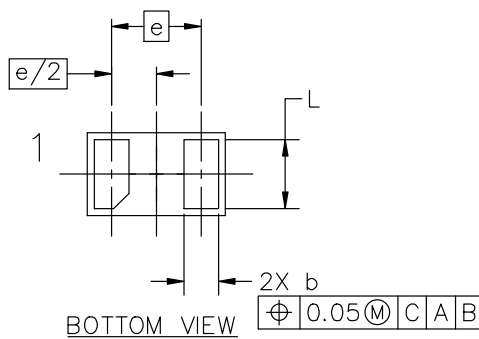

BOTTOM VIEW

NOTES:

1. DIMENSIONING AND TOLERANCING CONFORM TO ASME Y14.5–2018.
2. ALL DIMENSION ARE IN MILLIMETERS.
3. EXPOSED COPPER ALLOWED AS SHOW.

DIM	MILLIMETERS		
	MIN.	NOM.	MAX.
A	0.34	0.37	0.40
A1	---	0.03	0.050
b	0.20	0.25	0.30
D	0.95	1.00	1.05
E	0.55	0.60	0.65
e	0.65 BSC		
L	0.45	0.50	0.55

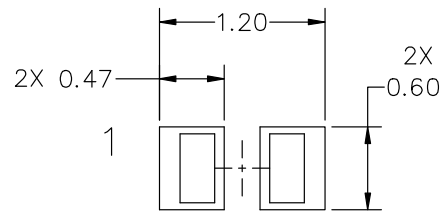

RECOMMENDED MOUNTING FOOTPRINT*

* FOR ADDITIONAL INFORMATION ON OUR Pb-FREE STRATEGY AND SOLDERING DETAILS, PLEASE DOWNLOAD THE ON SEMICONDUCTOR SOLDERING AND MOUNTING TECHNIQUES REFERENCE MANUAL, SOLDERRM/D.

GENERIC MARKING DIAGRAM*

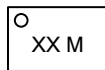

XX = Specific Device Code
M = Date Code

*This information is generic. Please refer to device data sheet for actual part marking. Pb-Free indicator, "G" or microdot "▪", may or may not be present. Some products may not follow the Generic Marking.

DOCUMENT NUMBER:	98AON98172F	Electronic versions are uncontrolled except when accessed directly from the Document Repository. Printed versions are uncontrolled except when stamped "CONTROLLED COPY" in red.
DESCRIPTION:	X2DFN2 1.00x0.60x0.37, 0.65P	PAGE 1 OF 1

onsemi and ONSEMI are trademarks of Semiconductor Components Industries, LLC dba onsemi or its subsidiaries in the United States and/or other countries. onsemi reserves the right to make changes without further notice to any products herein. onsemi makes no warranty, representation or guarantee regarding the suitability of its products for any particular purpose, nor does onsemi assume any liability arising out of the application or use of any product or circuit, and specifically disclaims any and all liability, including without limitation special, consequential or incidental damages. onsemi does not convey any license under its patent rights nor the rights of others.

onsemi, **Onsemi**, and other names, marks, and brands are registered and/or common law trademarks of Semiconductor Components Industries, LLC dba "**onsemi**" or its affiliates and/or subsidiaries in the United States and/or other countries. **onsemi** owns the rights to a number of patents, trademarks, copyrights, trade secrets, and other intellectual property. A listing of **onsemi**'s product/patent coverage may be accessed at www.onsemi.com/site/pdf/Patent-Marking.pdf. **onsemi** reserves the right to make changes at any time to any products or information herein, without notice. The information herein is provided "as-is" and **onsemi** makes no warranty, representation or guarantee regarding the accuracy of the information, product features, availability, functionality, or suitability of its products for any particular purpose, nor does **onsemi** assume any liability arising out of the application or use of any product or circuit, and specifically disclaims any and all liability, including without limitation special, consequential or incidental damages. Buyer is responsible for its products and applications using **onsemi** products, including compliance with all laws, regulations and safety requirements or standards, regardless of any support or applications information provided by **onsemi**. "Typical" parameters which may be provided in **onsemi** data sheets and/or specifications can and do vary in different applications and actual performance may vary over time. All operating parameters, including "Typicals" must be validated for each customer application by customer's technical experts. **onsemi** does not convey any license under any of its intellectual property rights nor the rights of others. **onsemi** products are not designed, intended, or authorized for use as a critical component in life support systems or any FDA Class 3 medical devices or medical devices with a same or similar classification in a foreign jurisdiction or any devices intended for implantation in the human body. Should Buyer purchase or use **onsemi** products for any such unintended or unauthorized application, Buyer shall indemnify and hold **onsemi** and its officers, employees, subsidiaries, affiliates, and distributors harmless against all claims, costs, damages, and expenses, and reasonable attorney fees arising out of, directly or indirectly, any claim of personal injury or death associated with such unintended or unauthorized use, even if such claim alleges that **onsemi** was negligent regarding the design or manufacture of the part. **onsemi** is an Equal Opportunity/Affirmative Action Employer. This literature is subject to all applicable copyright laws and is not for resale in any manner.

ADDITIONAL INFORMATION

TECHNICAL PUBLICATIONS:

Technical Library: www.onsemi.com/design/resources/technical-documentation
onsemi Website: www.onsemi.com

ONLINE SUPPORT: www.onsemi.com/support

For additional information, please contact your local Sales Representative at www.onsemi.com/support/sales