

Click [here](#) for production status of specific part numbers.

## MAX44244/MAX44245/ MAX44248

## 36V, Precision, Low-Power, 90 $\mu$ A, Single/Quad/Dual Op Amps

### General Description

The MAX44244/MAX44245/MAX44248 family of parts provide ultra-precision, low-noise, zero-drift single/quad/dual operational amplifiers featuring very low-power operation with a wide supply range. The devices incorporate a patented auto-zero circuit that constantly measures and compensates the input offset to eliminate drift over time and temperature as well as the effect of 1/f noise. These devices also feature integrated EMI filters to reduce high-frequency signal demodulation on the output. The op amps operate from either a single 2.7V to 36V supply or dual  $\pm 1.35$ V to  $\pm 18$ V supply. The devices are unity-gain stable with a 1MHz gain-bandwidth product and a low 90 $\mu$ A supply current per amplifier.

The low offset and noise specifications and high supply range make the devices ideal for sensor interfaces and transmitters.

The devices are available in  $\mu$ MAX<sup>®</sup>, SO, SOT23, and TSSOP packages and are specified over the  $-40^{\circ}$ C to  $+125^{\circ}$ C automotive operating temperature range.

### Applications

- Sensors Interfaces
- 4mA to 20mA and 0 to 10V Transmitters
- PLC Analog I/O Modules
- Weight Scales
- Portable Medical Devices

### Typical Operating Circuit

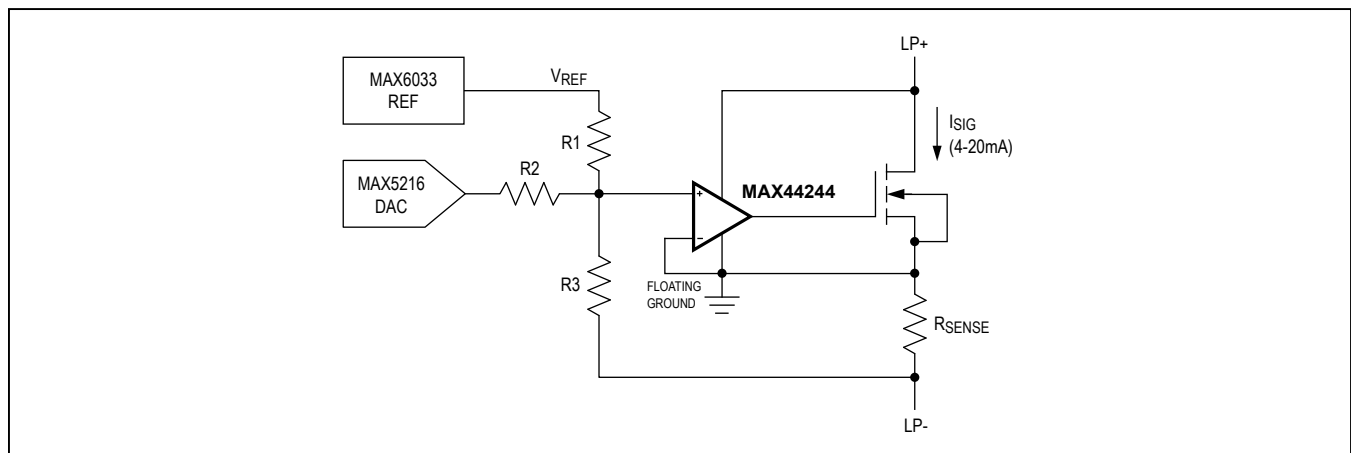

### Benefits and Features

- Reduces Power for Sensitive Precision Applications
  - Low 90 $\mu$ A Quiescent Current per Amplifier
- Eliminates the Cost of Calibration with Increased Accuracy with Maxim's Patented Autozero Circuitry
  - Very Low Input Voltage Offset 7.5 $\mu$ V (max)
  - Low 30nV/ $^{\circ}$ C Offset Drift (max)
- Low Noise Ideal for Sensor Interfaces and Transmitters
  - 50nV/ $\sqrt{\text{Hz}}$  at 1kHz
  - 0.5 $\mu$ V<sub>P-P</sub> from 0.1Hz to 10Hz
- 1MHz Gain-Bandwidth Product
  - EMI Suppression Circuitry
- Rail-to-Rail Output
- Wide Supply for High-Voltage Front Ends
  - 2.7V to 36V Supply Range
- $\mu$ MAX, SO, SOT23, TSSOP Packages

*Ordering Information* appears at end of data sheet.

*$\mu$ MAX is a registered trademark of Maxim Integrated Products, Inc.*

### Absolute Maximum Ratings

V <sub>DD</sub> to V <sub>SS</sub> .....	-0.3V to +40V
Common-Mode Input Voltage..... (V <sub>SS</sub> - 0.3V) to (V <sub>DD</sub> + 0.3V)	
Differential Input Voltage IN <sub>+</sub> , IN <sub>-</sub> .....	6V
Continuous Input Current Into Any Pin.....	±20mA
Output Voltage to V <sub>SS</sub> (OUT <sub>-</sub> ).....	- 0.3V to (V <sub>DD</sub> + 0.3V)
Output Short-Circuit Duration (OUT <sub>-</sub> ).....	1s

Operating Temperature Range.....	-40°C to +125°C
Storage Temperature.....	-65°C to +150°C
Junction Temperature.....	+150°C
Lead Temperature (soldering, 10s) .....	+300°C
Soldering Temperature (reflow).....	+260°C

Stresses beyond those listed under "Absolute Maximum Ratings" may cause permanent damage to the device. These are stress ratings only, and functional operation of the device at these or any other conditions beyond those indicated in the operational sections of the specifications is not implied. Exposure to absolute maximum rating conditions for extended periods may affect device reliability.

### Package Thermal Characteristics (Note 1)

#### SO-8

Junction-to-Ambient Thermal Resistance (θ <sub>JA</sub> ) .....	132°C/W
Junction-to-Case Thermal Resistance (θ <sub>JC</sub> ).....	38°C/W

#### SO-14

Junction-to-Ambient Thermal Resistance (θ <sub>JA</sub> ) .....	120°C/W
Junction-to-Case Thermal Resistance (θ <sub>JC</sub> ).....	37°C/W

#### SOT23

Junction-to-Ambient Thermal Resistance (θ <sub>JA</sub> ) .....	324.3°C/W
Junction-to-Case Thermal Resistance (θ <sub>JC</sub> ).....	82°C/W

#### TSSOP

Junction-to-Ambient Thermal Resistance (θ <sub>JA</sub> ) .....	110°C/W
Junction-to-Case Thermal Resistance (θ <sub>JC</sub> ).....	30°C/W

#### µMAX

Junction-to-Ambient Thermal Resistance (θ <sub>JA</sub> ) .....	206.3°C/W
Junction-to-Case Thermal Resistance (θ <sub>JC</sub> ).....	42°C/W

**Note 1:** Package thermal resistances were obtained using the method described in JEDEC specification JESD51-7, using a four-layer board. For detailed information on package thermal considerations, refer to [www.maximintegrated.com/thermal-tutorial](http://www.maximintegrated.com/thermal-tutorial).

### Electrical Characteristics

(V<sub>DD</sub> = 10V, V<sub>SS</sub> = 0V, V<sub>IN+</sub> = V<sub>IN-</sub> = V<sub>DD</sub>/2, R<sub>L</sub> = 5kΩ to V<sub>DD</sub>/2, T<sub>A</sub> = -40°C to +125°C, unless otherwise noted. Typical values are at +25°C.) (Note 2)

PARAMETER	SYMBOL	CONDITIONS	MIN	TYP	MAX	UNITS
<b>POWER SUPPLY</b>						
Supply Voltage Range	V <sub>DD</sub>	Guaranteed by PSRR	2.7		36	V
Power-Supply Rejection Ratio (Note 3)	PSRR	T <sub>A</sub> = +25°C, V <sub>IN+</sub> = V <sub>IN-</sub> = V <sub>DD</sub> /2 - 1V	140	148		dB
		-40°C < T <sub>A</sub> < +125°C	133			
Quiescent Current Per Amplifier (MAX4244 Only)	I <sub>DD</sub>	T <sub>A</sub> = +25°C		100	160	µA
		-40°C < T <sub>A</sub> < +125°C			190	
Quiescent Current Per Amplifier (MAX44245/MAX44248 Only)	I <sub>DD</sub>	T <sub>A</sub> = +25°C		90	130	µA
		-40°C < T <sub>A</sub> < +125°C			145	
<b>DC SPECIFICATIONS</b>						
Input Common-Mode Range	V <sub>CM</sub>	Guaranteed by CMRR test	V <sub>SS</sub> - 0.05		V <sub>DD</sub> - 1.5	V

**Electrical Characteristics (continued)**

(V<sub>DD</sub> = 10V, V<sub>SS</sub> = 0V, V<sub>IN+</sub> = V<sub>IN-</sub> = V<sub>DD</sub>/2, R<sub>L</sub> = 5kΩ to V<sub>DD</sub>/2, T<sub>A</sub> = -40°C to +125°C, unless otherwise noted. Typical values are at +25°C.) (Note 2)

PARAMETER	SYMBOL	CONDITIONS		MIN	TYP	MAX	UNITS
Common-Mode Rejection Ratio (Note 3)	CMRR	T <sub>A</sub> = +25°C, V <sub>CM</sub> = V <sub>SS</sub> - 0.05V to V <sub>DD</sub> - 1.5V		126	130		dB
		-40°C < T <sub>A</sub> < +125°C, V <sub>CM</sub> = V <sub>SS</sub> - 0.05V to V <sub>DD</sub> - 1.5V		120			
Input Offset Voltage (Note 3)	V <sub>OS</sub>	T <sub>A</sub> = +25°C			2	7.5	µV
		-40°C < T <sub>A</sub> < +125°C				10	
Input Offset Voltage Drift (Note 3)	TC V <sub>OS</sub>				10	30	nV/°C
Input Bias Current (Note 3)	I <sub>B</sub>	T <sub>A</sub> = +25°C			150	300	pA
		-40°C < T <sub>A</sub> < +125°C				700	
Input Offset Current (Note 3)	I <sub>OS</sub>	T <sub>A</sub> = +25°C			300	600	pA
		-40°C < T <sub>A</sub> < +125°C				1400	
Open-Loop Gain (Note 3)	A <sub>VOL</sub>	V <sub>SS</sub> + 0.5V ≤ V <sub>OUT</sub> ≤ V <sub>DD</sub> - 0.5V	T <sub>A</sub> = +25°C	140	150		dB
			-40°C < T <sub>A</sub> < +125°C	135			
Output Short-Circuit Current		To V <sub>DD</sub> or V <sub>SS</sub> , noncontinuous			40		mA
Output Voltage Swing	V <sub>DD</sub> - V <sub>OUT</sub>	T <sub>A</sub> = +25°C				80	mV
		-40°C < T <sub>A</sub> < +125°C				110	
	V <sub>OUT</sub> - V <sub>SS</sub>	T <sub>A</sub> = +25°C				50	
		-40°C < T <sub>A</sub> < +125°C				75	
<b>AC SPECIFICATIONS</b>							
Input Voltage-Noise Density	e <sub>N</sub>	f = 1kHz			50		nV/√Hz
Input Voltage Noise		0.1Hz < f < 10Hz			500		nV <sub>P-P</sub>
Input Current-Noise Density	i <sub>N</sub>	f = 1kHz			0.1		pA/√Hz
Gain-Bandwidth Product	GBW				1		MHz
Slew Rate	SR	A <sub>V</sub> = 1V/V, V <sub>OUT</sub> = 2V <sub>P-P</sub>			0.7		V/µs
Capacitive Loading	C <sub>L</sub>	No sustained oscillation, A <sub>V</sub> = 1V/V			400		pF
Total Harmonic Distortion Plus Noise	THD+N	V <sub>OUT</sub> = 2V <sub>P-P</sub> , A <sub>V</sub> = +1V/V, f = 1kHz			-100		dB
EMI Rejection Ratio	EMIRR	V <sub>RF_PEAK</sub> = 100mV	f = 400MHz		75		dB
			f = 900MHz		78		
			f = 1800MHz		80		
			f = 2400MHz		90		

MAX44244/MAX44245/  
MAX44248

36V, Precision, Low-Power, 90µA,  
Single/Quad/Dual Op Amps

**Electrical Characteristics (continued)**

( $V_{DD} = 30V$ ,  $V_{SS} = 0V$ ,  $V_{IN+} = V_{IN-} = V_{DD}/2$ ,  $R_L = 5k\Omega$  to  $V_{DD}/2$ ,  $T_A = -40^\circ C$  to  $+125^\circ C$ , unless otherwise noted. Typical values are at  $+25^\circ C$ .) (Note 2)

PARAMETER	SYMBOL	CONDITIONS	MIN	TYP	MAX	UNITS
<b>POWER SUPPLY</b>						
Quiescent Current Per Amplifier (MAX44244 Only)	$I_{DD}$	$T_A = +25^\circ C$		100	160	$\mu A$
		$-40^\circ C < T_A < +125^\circ C$			190	
Quiescent Current Per Amplifier (MAX44245/MAX44248 Only)	$I_{DD}$	$T_A = +25^\circ C$		90	130	$\mu A$
		$-40^\circ C < T_A < +125^\circ C$			145	
<b>DC SPECIFICATIONS</b>						
Input Common-Mode Range	$V_{CM}$	Guaranteed by CMRR test	$V_{SS} - 0.05$		$V_{DD} - 1.5$	V
Common-Mode Rejection Ratio (Note 3)	CMRR	$T_A = +25^\circ C$ , $V_{CM} = V_{SS} - 0.05V$ to $V_{DD} - 1.5V$	130	140		dB
		$-40^\circ C < T_A < +125^\circ C$ , $V_{CM} = V_{SS} - 0.05V$ to $V_{DD} - 1.5V$	126			
Input Offset Voltage (Note 3)	$V_{OS}$	$T_A = +25^\circ C$		2	7.5	$\mu V$
		$-40^\circ C < T_A < +125^\circ C$			10	
Input Offset Voltage Drift (Note 3)	TC $V_{OS}$			10	30	nV/ $^\circ C$
Input Bias Current (Note 3)	$I_B$	$T_A = +25^\circ C$		150	300	pA
		$-40^\circ C < T_A < +125^\circ C$			700	
Input Offset Current (Note 3)	$I_{OS}$	$T_A = +25^\circ C$		300	600	pA
		$-40^\circ C < T_A < +125^\circ C$			1400	
Open-Loop Gain (Note 3)	$A_{VOL}$	$V_{SS} + 0.5V \leq V_{OUT} \leq V_{DD} - 0.5V$	$T_A = +25^\circ C$	146	150	dB
			$-40^\circ C < T_A < +125^\circ C$	140		
Output Short-Circuit Current		To $V_{DD}$ or $V_{SS}$ , noncontinuous		40		mA
Output Voltage Swing	$V_{DD} - V_{OUT}$	$T_A = +25^\circ C$			200	mV
		$-40^\circ C < T_A < +125^\circ C$			270	
	$V_{OUT} - V_{SS}$	$T_A = +25^\circ C$			140	
		$-40^\circ C < T_A < +125^\circ C$			220	
<b>AC SPECIFICATIONS</b>						
Input Voltage-Noise Density	$e_N$	$f = 1kHz$		50		nV/ $\sqrt{Hz}$
Input Voltage Noise		$0.1Hz < f < 10Hz$		500		nV <sub>p-p</sub>
Input Current-Noise Density	$i_N$	$f = 1kHz$		0.1		pA/ $\sqrt{Hz}$
Gain-Bandwidth Product	GBW			1		MHz

### Electrical Characteristics (continued)

( $V_{DD} = 30V$ ,  $V_{SS} = 0V$ ,  $V_{IN+} = V_{IN-} = V_{DD}/2$ ,  $R_L = 5k\Omega$  to  $V_{DD}/2$ ,  $T_A = -40^\circ C$  to  $+125^\circ C$ , unless otherwise noted. Typical values are at  $+25^\circ C$ .) (Note 2)

PARAMETER	SYMBOL	CONDITIONS	MIN	TYP	MAX	UNITS
Slew Rate	SR	$A_V = 1V/V$ , $V_{OUT} = 2V_{P-P}$		0.7		V/ $\mu s$
Capacitive Loading	$C_L$	No sustained oscillation, $A_V = 1V/V$		400		pF
Total Harmonic Distortion Plus Noise	THD+N	$V_{OUT} = 2V_{P-P}$ , $A_V = +1V/V$ , $f = 1kHz$		-100		dB
EMI Rejection Ratio	EMIRR	$V_{RF\_PEAK} = 100mV$	$f = 400MHz$	75		dB
			$f = 900MHz$	78		
			$f = 1800MHz$	80		
			$f = 2400MHz$	90		

**Note 2:** All devices are 100% production tested at  $T_A = +25^\circ C$ . Temperature limits are guaranteed by design.

**Note 3:** Guaranteed by design.

**Note 4:** At  $IN+$  and  $IN-$ . Defined as  $20\log(V_{RF\_PEAK}/\Delta V_{OS})$ .

### Typical Operating Characteristics

( $V_{DD} = 10V$ ,  $V_{SS} = 0V$ ,  $V_{IN+} = V_{IN-} = V_{DD}/2$ ,  $R_L = 5k\Omega$  to  $V_{DD}/2$ . Typical values are at  $T_A = +25^\circ C$ .)

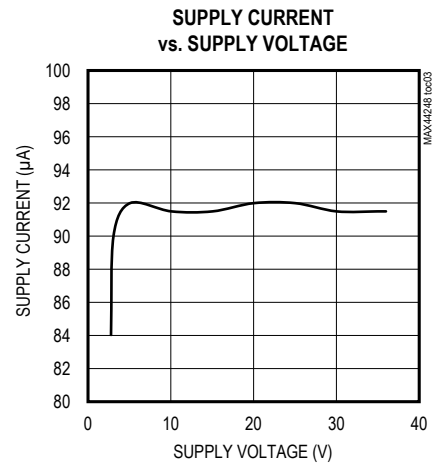
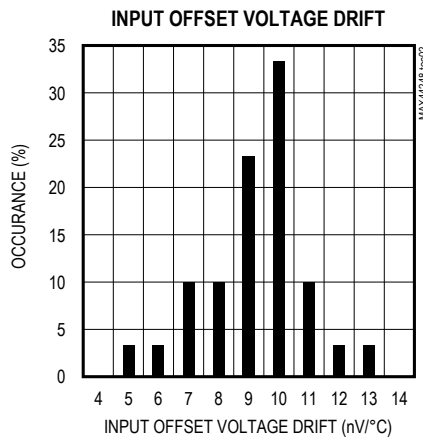
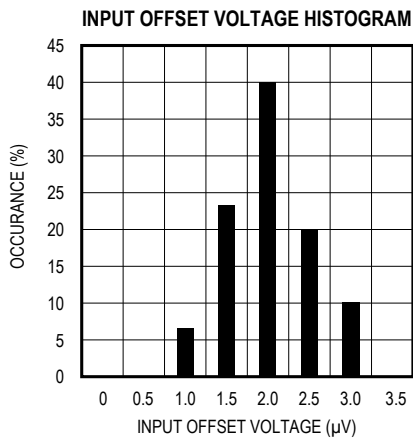

Typical Operating Characteristics (continued)

( $V_{DD} = 10V$ ,  $V_{SS} = 0V$ ,  $V_{IN+} = V_{IN-} = V_{DD}/2$ ,  $R_L = 5k\Omega$  to  $V_{DD}/2$ . Typical values are at  $T_A = +25^\circ C$ .)

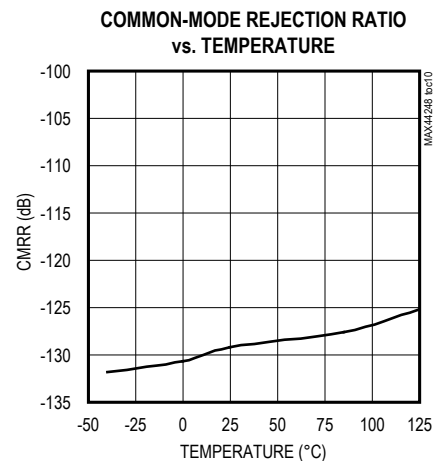
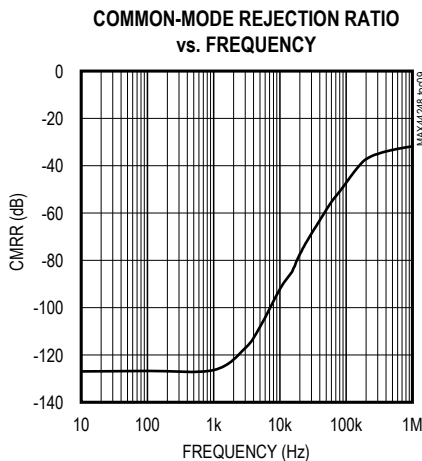
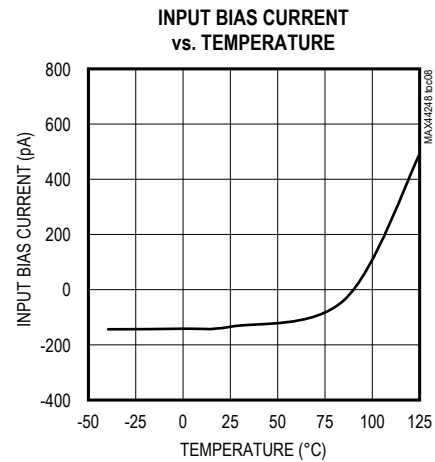
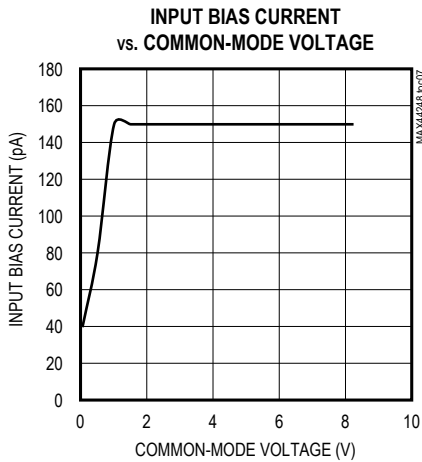
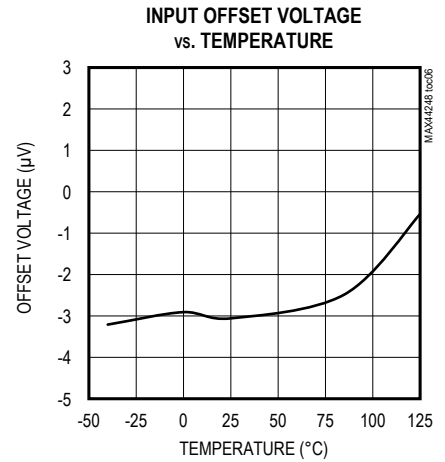
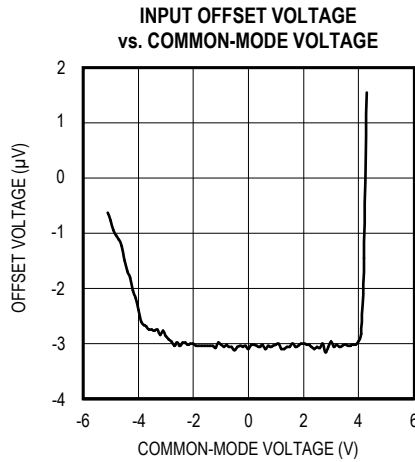
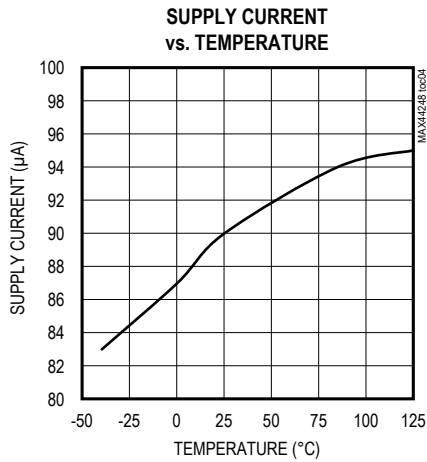

Typical Operating Characteristics (continued)

( $V_{DD} = 10V$ ,  $V_{SS} = 0V$ ,  $V_{IN+} = V_{IN-} = V_{DD}/2$ ,  $R_L = 5k\Omega$  to  $V_{DD}/2$ . Typical values are at  $T_A = +25^\circ C$ .)

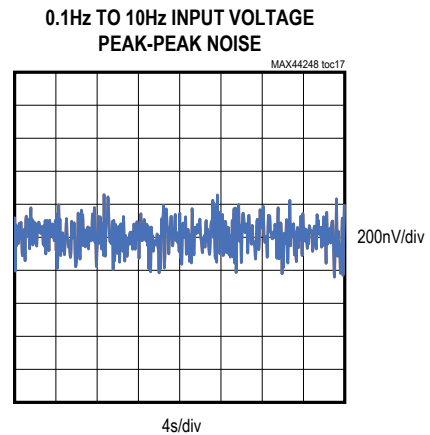
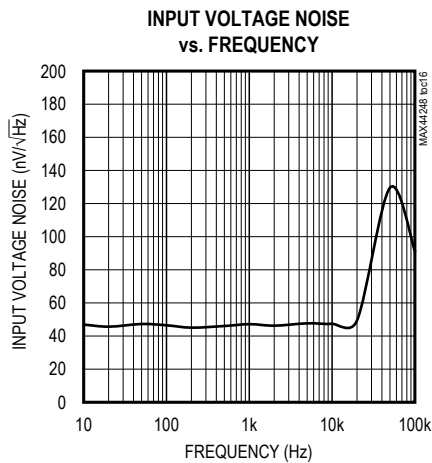
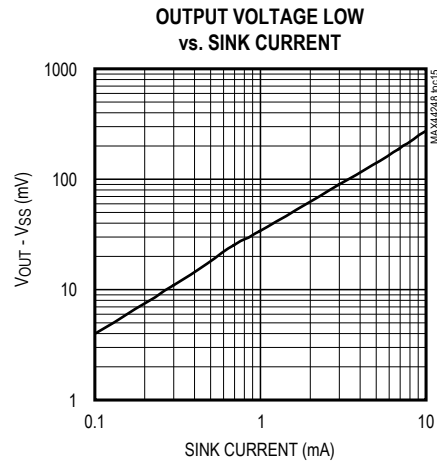
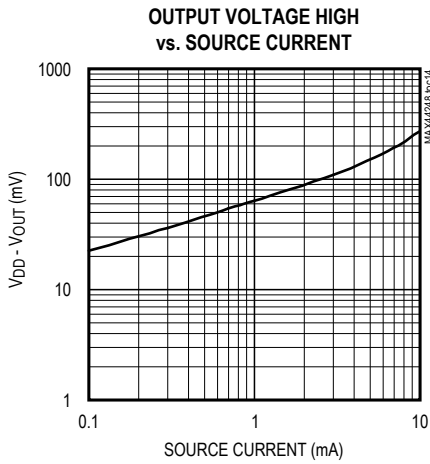
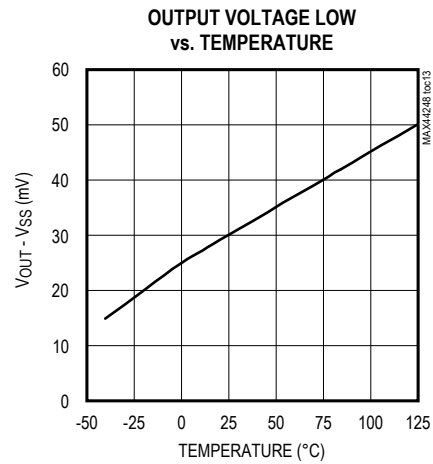
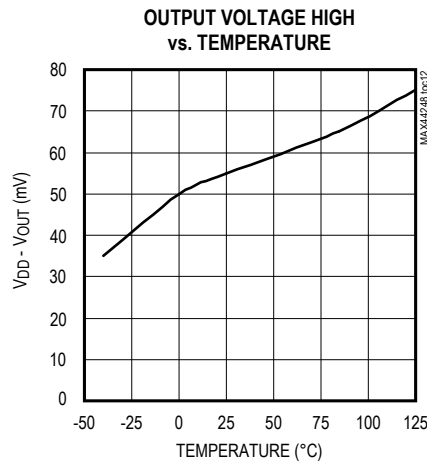
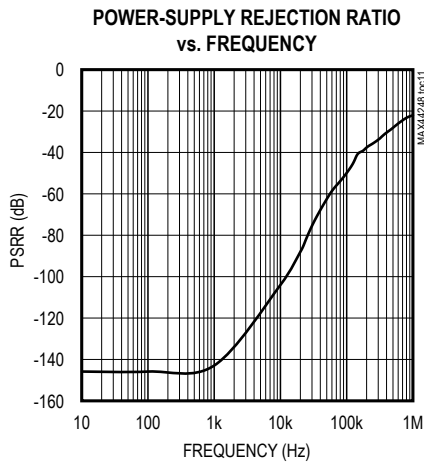

Typical Operating Characteristics (continued)

( $V_{DD} = 10V$ ,  $V_{SS} = 0V$ ,  $V_{IN+} = V_{IN-} = V_{DD}/2$ ,  $R_L = 5k\Omega$  to  $V_{DD}/2$ . Typical values are at  $T_A = +25^\circ C$ .)

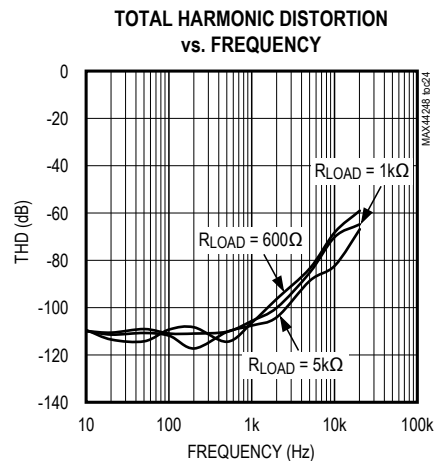
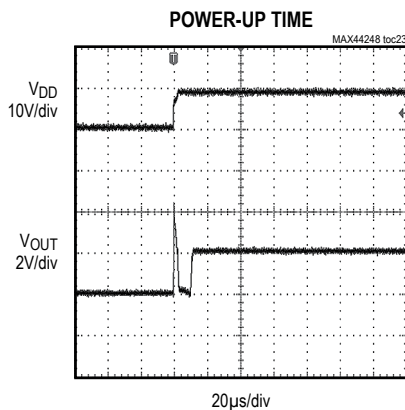
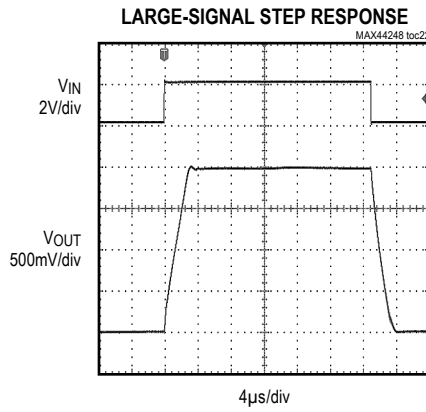
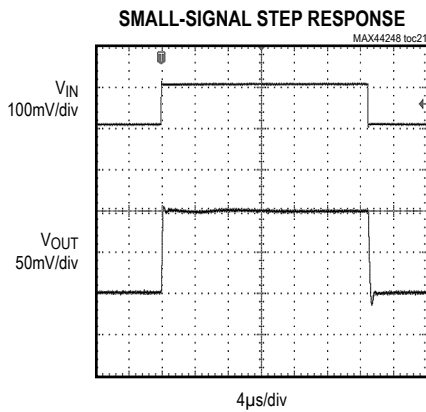
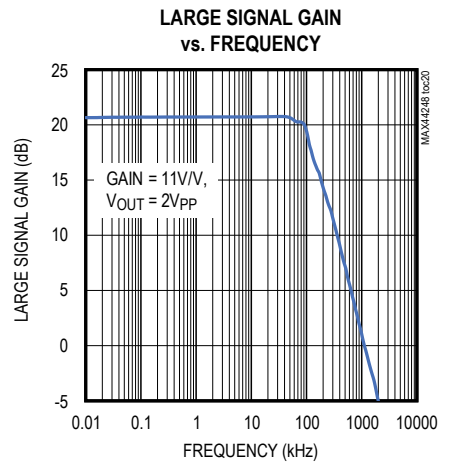
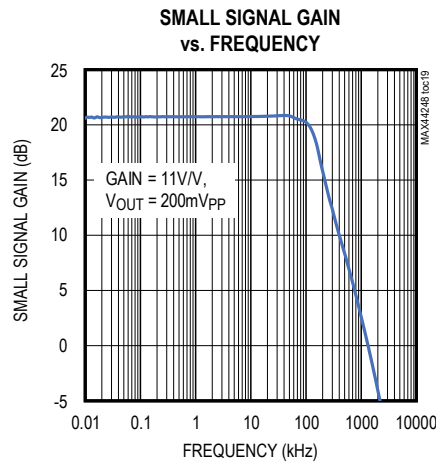
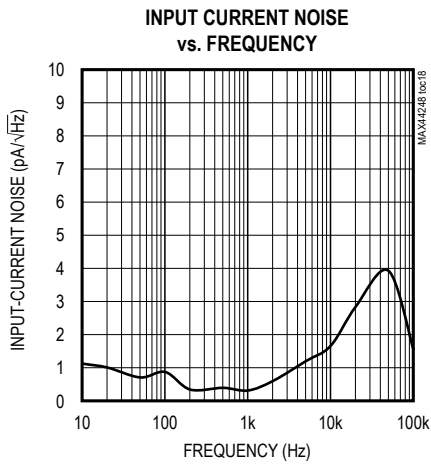



Typical Operating Characteristics (continued)

( $V_{DD} = 10V$ ,  $V_{SS} = 0V$ ,  $V_{IN+} = V_{IN-} = V_{DD}/2$ ,  $R_L = 5k\Omega$  to  $V_{DD}/2$ . Typical values are at  $T_A = +25^\circ C$ .)

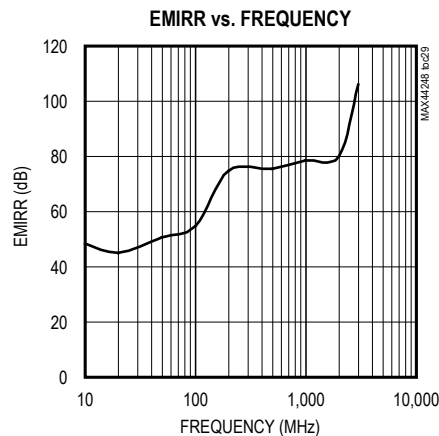
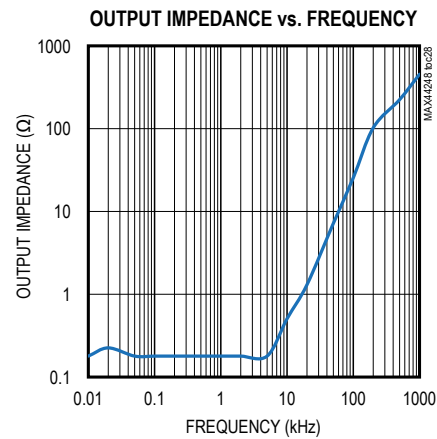
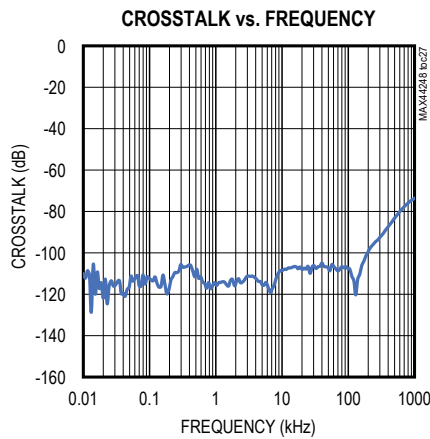
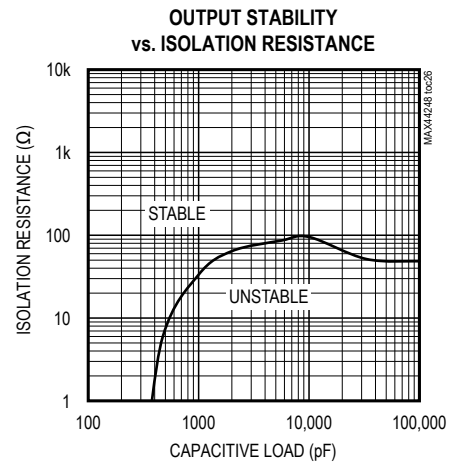
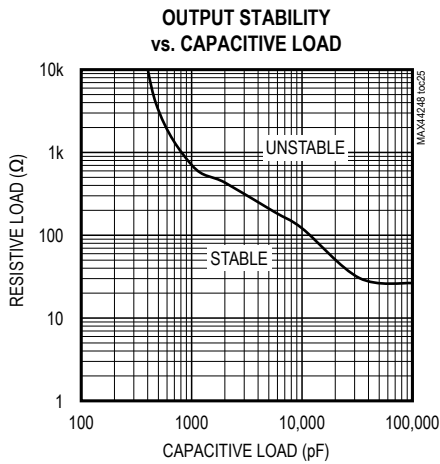

Pin Configurations

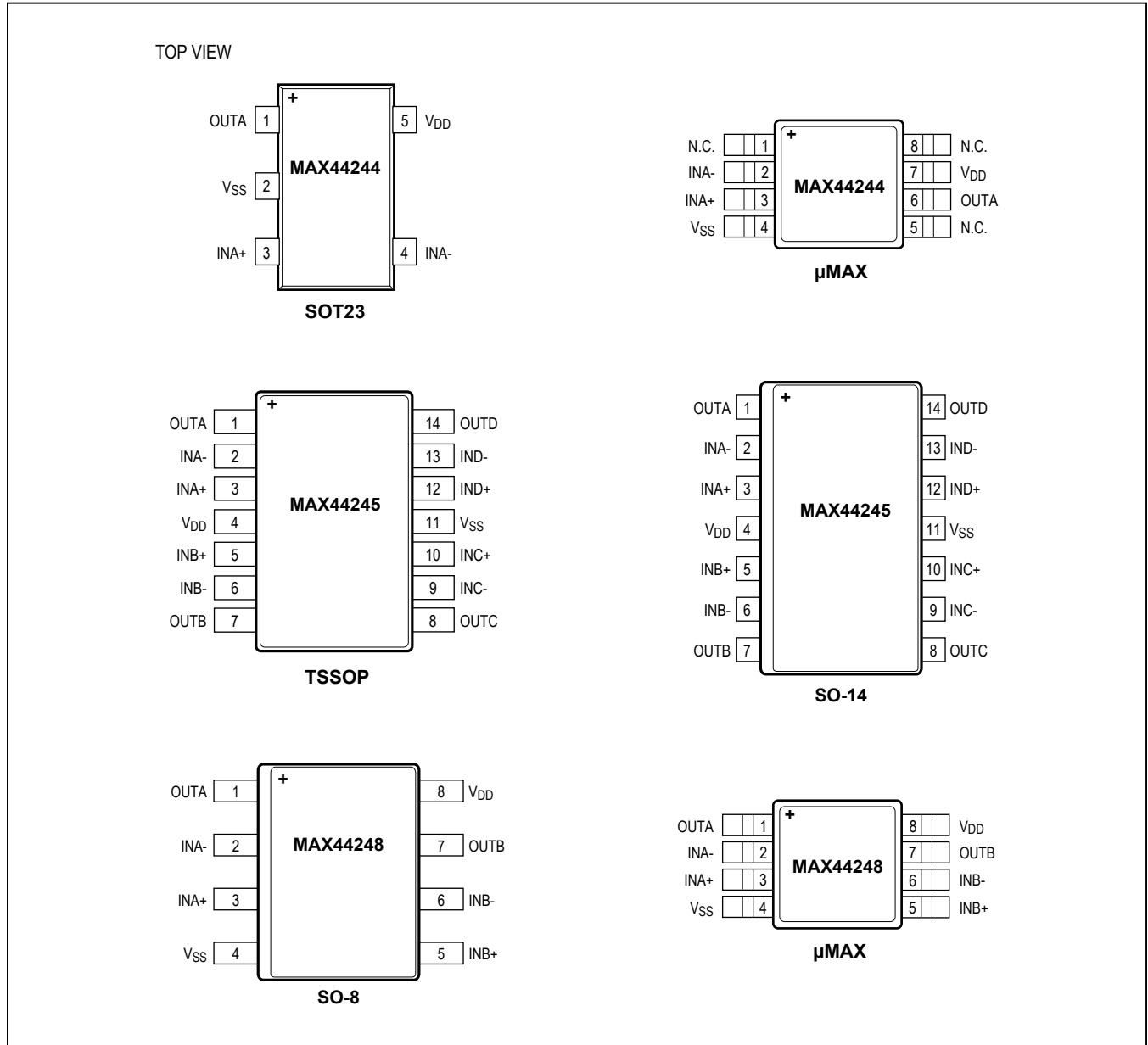

## Pin Description

PIN						NAME	FUNCTION
MAX44244		MAX44245		MAX44248			
SOT23	$\mu$ MAX	SO-14	TSSOP	SO-8	$\mu$ MAX		
1	6	1	1	1	1	OUTA	Channel A Output
2	4	11	11	4	4	V <sub>SS</sub>	Negative Supply Voltage
3	3	3	3	3	3	INA+	Channel A Positive Input
4	2	2	2	2	2	INA-	Channel A Negative Input
5	7	4	4	8	8	V <sub>DD</sub>	Positive Supply Voltage
—	—	5	5	5	5	INB+	Channel B Positive Input
—	—	6	6	6	6	INB-	Channel B Negative Input
—	—	7	7	7	7	OUTB	Channel B Output
—	—	8	8	—	—	OUTC	Channel C Output
—	—	9	9	—	—	INC-	Channel C Negative Input
—	—	10	10	—	—	INC+	Channel C Positive Input
—	—	12	12	—	—	IND+	Channel D Positive Input
—	—	13	13	—	—	IND-	Channel D Negative Input
—	—	14	14	—	—	OUTD	Channel D Output
—	1, 5, 8	—	—	—	—	N.C.	No Connection. Not internally connected.

## Detailed Description

The MAX44244/MAX44245/MAX44248 are high-precision amplifiers with less than 2 $\mu$ V (typ) input-referred offset and low input voltage-noise density at 10Hz. 1/f noise, in fact, is eliminated to improve the performance in low-frequency applications. These characteristics are achieved through an auto-zeroing technique that cancels the input offset voltage and 1/f noise of the amplifier.

### External Noise Suppression in EMI Form

These devices have input EMI filters to prevent effects of radio frequency interference on the output. The EMI filters comprise passive devices that present significant higher impedance to higher frequency signals. See the EMIRR vs. Frequency graph in the [Typical Operating Characteristics](#) section for details.

### High Supply Voltage Range

The devices feature 90 $\mu$ A current consumption per channel and a voltage supply range from either 2.7V to 36V single supply or  $\pm$ 1.35V to  $\pm$ 18V split supply.

## Applications Information

The devices feature ultra-high precision operational amplifiers with a high supply voltage range designed for load cell, medical instrumentation, and precision instrument applications.

### 4–20mA Current-Loop Communication

Industrial environments typically have a large amount of broadcast electromagnetic interference (EMI) from high-voltage transients and switching motors. This combined with long cables for sensor communication leads to high-voltage noise on communication lines. Current-Loop communication is resistant to this noise because the EMI induced current is low. This configuration also allows for low-power sensor applications to be powered from the communication lines.

The [Typical Operating Circuit](#) shows how the device can be used to make a current loop driver.

The circuit uses low-power components such as the MAX44244 op amp, the 16-bit MAX5216 DAC, and the high-precision 60µA-only MAX6033 reference. In this circuit, both the DAC and the reference are referred to the local ground. The MAX44244 op-amp inputs are capable of swinging to the negative supply (which is the local ground in this case). R3 acts as a current mirror with R<sub>SENSE</sub>. Therefore, if R<sub>SENSE</sub> = 50Ω (i.e. 20mA will drop 1V) and if the current through R3 is 10µA when I<sub>OUT</sub> is 20mA (0.05% error) then R3 = 100kΩ. R1 is chosen along with the reference voltage to provide the 4mA offset. R2 = 512kΩ for 20mA full scale or R2 = 614kΩ for 20% over-range. R<sub>SENSE</sub> is ratiometric with R3, R1 independently sets the offset current and R2 independently sets the DAC scaling.

### Driving High-Performance ADCs

The MAX44244/MAX44245/MAX44248's low input offset voltage and low noise make these amplifiers ideal for ADC buffering. Weight scale applications require a low-noise, precision amplifier in front of an ADC. [Figure 1](#) details an example of a load cell and amplifier driven from the same 5V supply, along with a 16-bit delta sigma ADC such as the MAX11205.

The MAX11205 is an ultra-low-power (< 300µA, max active current), high-resolution, serial output ADC. It provides the highest resolution per unit power in the industry and is optimized for applications that require very

high dynamic range with low power such as sensors on a 4–20mA industrial control loop. The devices provide a high-accuracy internal oscillator that requires no external components.

### Layout Guidelines

The MAX44244/MAX44245/MAX44248 feature ultra-low input offset voltage and noise. Therefore, to get optimum performance follow the layout guidelines.

Avoid temperature gradients at the junction of two dissimilar metals. The most common dissimilar metals used on a PCB are solder-to-component lead and solder-to-board trace. Dissimilar metals create a local thermocouple. A variation in temperature across the board can cause an additional offset due to Seebeck effect at the solder junctions. To minimize the Seebeck effect, place the amplifier away from potential heat sources on the board, if possible. Orient the resistors such that both the ends are heated equally. It is a good practice to match the input signal path to ensure that the type and number of thermoelectric junctions remain the same. For example, consider using dummy 0Ω resistors oriented in such a way that the thermoelectric source, due to the real resistors in the signal path, are cancelled. It is recommended to flood the PCB with ground plane. The ground plane ensures that heat is distributed uniformly reducing the potential offset voltage degradation due to Seebeck effect.

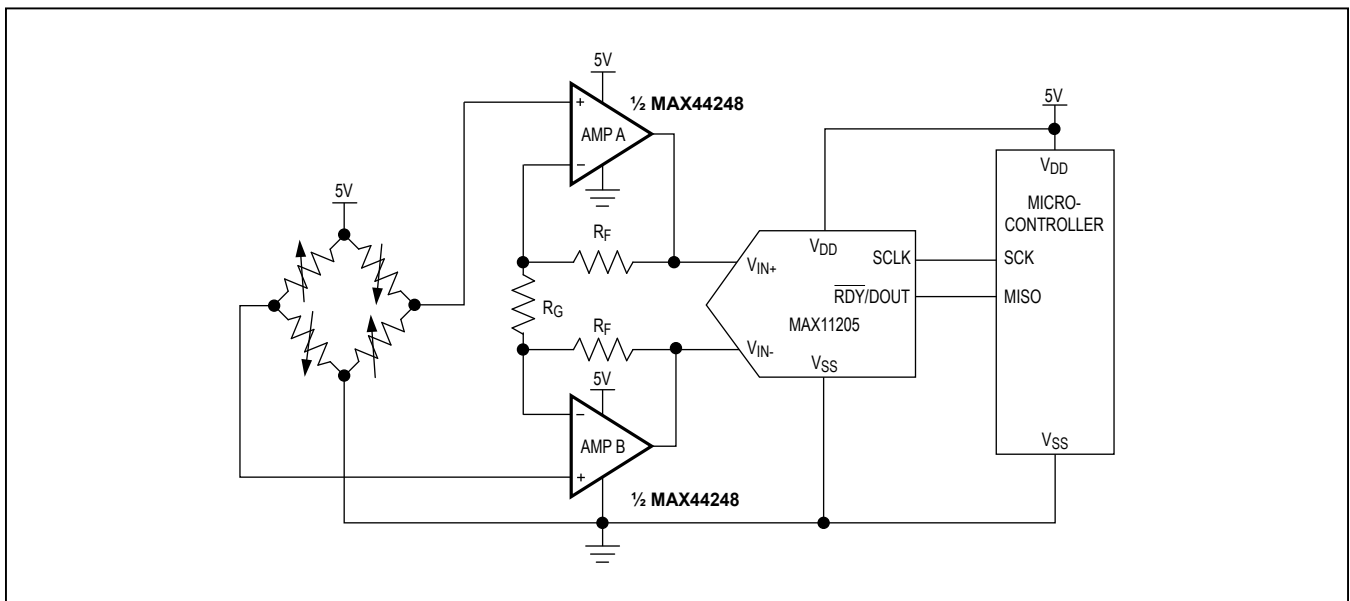

Figure 1. Weight Application

MAX44244/MAX44245/  
MAX44248

36V, Precision, Low-Power, 90µA,  
Single/Quad/Dual Op Amps

## Chip Information

PROCESS: BICMOS

## Ordering Information

PART	TEMP RANGE	PIN-PACKAGE	TOP MARK
<b>MAX44244</b> AUK+	-40°C to +125°C	5 SOT23	AFMR
MAX44244AUA+	-40°C to +125°C	8 µMAX	—
<b>MAX44245</b> ASD+	-40°C to +125°C	14 SO	—
MAX44245AUD+	-40°C to +125°C	14 TSSOP	—
<b>MAX44248</b> AUA+	-40°C to +125°C	8 µMAX	—
MAX44248ASA+	-40°C to +125°C	8 SO	—

+Denotes a lead(Pb)-free/RoHS-compliant package.

## Package Information

For the latest package outline information and land patterns (footprints), go to [www.maximintegrated.com/packages](http://www.maximintegrated.com/packages). Note that a "+", "#", or "-" in the package code indicates RoHS status only. Package drawings may show a different suffix character, but the drawing pertains to the package regardless of RoHS status.

PACKAGE TYPE	PACKAGE CODE	OUTLINE NO.	LAND PATTERN NO.
5 SOT23	U5+1	<a href="#">21-0057</a>	<a href="#">90-0174</a>
8 SO	S8+4	<a href="#">21-0041</a>	<a href="#">90-0096</a>
8 µMAX	U8+1	<a href="#">21-0036</a>	<a href="#">90-0092</a>
14 SO	S14M+4	<a href="#">21-0041</a>	<a href="#">90-0112</a>
14 TSSOP	U14M+1	<a href="#">21-0066</a>	<a href="#">90-0113</a>

## Revision History

REVISION NUMBER	REVISION DATE	DESCRIPTION	PAGES CHANGED
0	7/12	Initial release	—
1	6/13	Added the MAX44244/MAX44245 to data sheet. Updated the <i>Electrical Characteristics, Absolute Maximum Ratings, Pin Description, and Pin Configurations</i> .	1–13
2	9/13	Released the MAX44244 for introduction. Revised the <i>Electrical Characteristics</i>	2–5, 13
3	6/14	Corrected Figure 1 and <i>Package Information</i>	12, 13
4	12/14	Updated <i>Benefits and Features</i> section	1
5	9/15	Updated <i>Typical Operating Circuit</i>	1
6	11/18	Updated <i>Typical Operating Characteristics</i>	7–9

For pricing, delivery, and ordering information, please visit Maxim Integrated's online storefront at <https://www.maximintegrated.com/en/storefront/storefront.html>.

Maxim Integrated cannot assume responsibility for use of any circuitry other than circuitry entirely embodied in a Maxim Integrated product. No circuit patent licenses are implied. Maxim Integrated reserves the right to change the circuitry and specifications without notice at any time. The parametric values (min and max limits) shown in the Electrical Characteristics table are guaranteed. Other parametric values quoted in this data sheet are provided for guidance.

# Mouser Electronics

Authorized Distributor

Click to View Pricing, Inventory, Delivery & Lifecycle Information:

[Analog Devices Inc.:](#)

[MAX44245ASD+T](#) [MAX44245AUD+](#)

Other:

[MAX44245AUD+T](#) [MAX44245ASD+](#)