

APT1608SURCK-AMT

1.6 x 0.8 mm SMD Chip LED Lamp

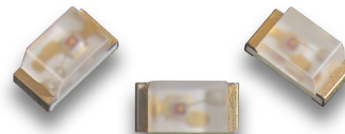

DESCRIPTIONS

- The Hyper Red source color devices are made with AlGaInP on GaAs substrate Light Emitting Diode
- Electrostatic discharge and power surge could damage the LEDs
- It is recommended to use a wrist band or anti-electrostatic glove when handling the LEDs
- All devices, equipments and machineries must be electrically grounded

FEATURES

- 1.6 mm x 0.8 mm SMD LED, 0.75 mm thickness
- Low power consumption
- Wide viewing angle
- Ideal for backlight and indicator
- Package: 2000 pcs / reel
- Moisture sensitivity level: 3
- Halogen-free
- RoHS compliant

APPLICATIONS

- Traffic signaling
- Backlighting (illuminated advertising , general lighting)
- Interior and exterior automotive lighting
- Substitution of micro incandescent lamps
- Reading lamps
- Signal and symbol luminaire for orientation
- Marker lights (e.g. Steps, exit ways, etc)
- Decorative and entertainment lighting
- Indoor and outdoor commercial and residential architectural lighting

ATTENTION

Observe precautions for handling electrostatic discharge sensitive devices



PACKAGE DIMENSIONS

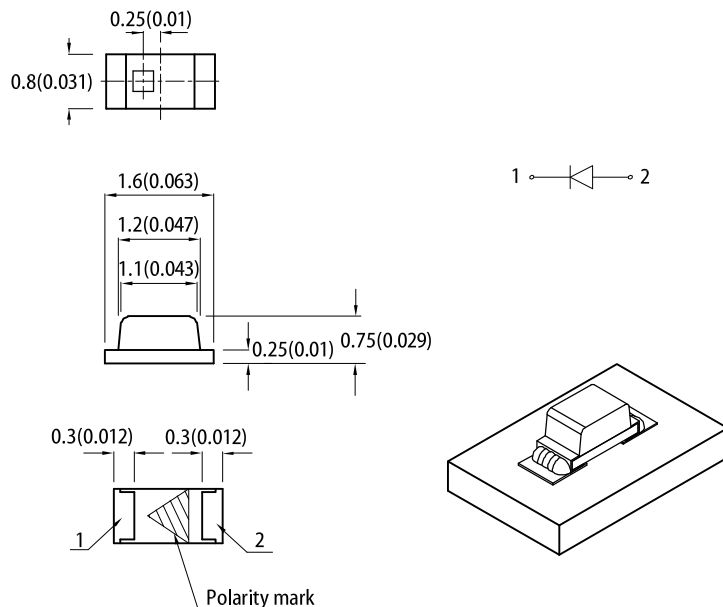

RECOMMENDED SOLDERING PATTERN

(units : mm; tolerance : ± 0.1)

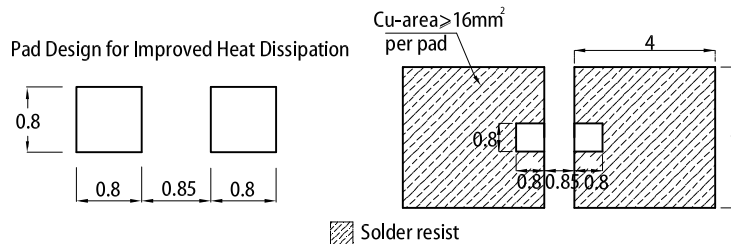

Notes:

1. All dimensions are in millimeters (inches).
2. Tolerance is ±0.1(0.004") unless otherwise noted.
3. The specifications, characteristics and technical data described in the datasheet are subject to change without prior notice.
4. The device has a single mounting surface. The device must be mounted according to the specifications.

SELECTION GUIDE

| Part Number | Emitting Color (Material) | Lens Type | Iv (mcd) @ 20mA ^[2] | | | Viewing Angle ^[1] |
|------------------|---------------------------|-------------|--------------------------------|------|------|------------------------------|
| | | | Code. | Min. | Max. | 2θ1/2 |
| APT1608SURCK-AMT | ■ Hyper Red (AlGaInP) | Water Clear | N | 120 | 200 | 120° |
| | | | P | 200 | 300 | |
| | | | Q | 300 | 400 | |
| | | | *F | *20 | *40 | |
| | | | *G | *40 | *55 | |
| | | | *H | *55 | *80 | |
| | | | *M | *80 | *120 | |

Notes:
 1. θ1/2 is the angle from optical centerline where the luminous intensity is 1/2 of the optical peak value.
 2. Luminous intensity / luminous flux: +/-15%.
 * Luminous intensity value is traceable to CIE127-2007 standards.
 3. LEDs will be provided from the listed bin codes. The bins delivered to the customer will be at Kingbright's discretion.

ELECTRICAL / OPTICAL CHARACTERISTICS at $T_A=25^\circ\text{C}$

| Parameter | Symbol | Emitting Color | Value | | | Unit |
|---|---------------------------------------|----------------|-------|------|------|----------------------------|
| | | | Min. | Typ. | Max. | |
| Wavelength at Peak Emission $I_F = 20\text{mA}$ | λ_{peak} | Hyper Red | - | 645 | - | nm |
| Dominant Wavelength $I_F = 20\text{mA}$ | λ_{dom} ^[1] | Hyper Red | 620 | - | 640 | nm |
| Spectral Bandwidth at 50% Φ REL MAX $I_F = 20\text{mA}$ | $\Delta\lambda$ | Hyper Red | - | 28 | - | nm |
| Capacitance | C | Hyper Red | - | 35 | - | pF |
| Forward Voltage $I_F = 20\text{mA}$ | V_F ^[2] | Hyper Red | - | 1.95 | 2.5 | V |
| Reverse Current ($V_R = 5\text{V}$) | I_R | Hyper Red | - | - | 10 | μA |
| Temperature Coefficient of λ_{peak} $I_F = 20\text{mA}$, $-10^\circ\text{C} \leq T \leq 100^\circ\text{C}$ | $\text{TC}_{\lambda_{\text{peak}}}$ | Hyper Red | - | 0.14 | - | $\text{nm}/^\circ\text{C}$ |
| Temperature Coefficient of λ_{dom} $I_F = 20\text{mA}$, $-10^\circ\text{C} \leq T \leq 100^\circ\text{C}$ | $\text{TC}_{\lambda_{\text{dom}}}$ | Hyper Red | - | 0.05 | - | $\text{nm}/^\circ\text{C}$ |
| Temperature Coefficient of V_F $I_F = 20\text{mA}$, $-10^\circ\text{C} \leq T \leq 100^\circ\text{C}$ | TC_V | Hyper Red | - | -1.9 | - | $\text{mV}/^\circ\text{C}$ |

Notes:

- The dominant wavelength (λ_d) above is the setup value of the sorting machine. (Tolerance $\lambda_d : \pm 1\text{nm}$.)
- Forward voltage: $\pm 0.1\text{V}$.
- Wavelength value is traceable to CIE127-2007 standards.
- Excess driving current and / or operating temperature higher than recommended conditions may result in severe light degradation or premature failure.

ABSOLUTE MAXIMUM RATINGS at $T_A=25^\circ\text{C}$

| Parameter | Symbol | Value | Unit |
|--|-----------------------------------|-------------|---------------------------|
| Power Dissipation | P_D | 75 | mW |
| Reverse Voltage | V_R | 5 | V |
| Junction Temperature | T_j | 115 | $^\circ\text{C}$ |
| Operating Temperature | T_{op} | -40 to +100 | $^\circ\text{C}$ |
| Storage Temperature | T_{stg} | -40 to +115 | $^\circ\text{C}$ |
| DC Forward Current | I_F | 30 | mA |
| Peak Forward Current | I_{FM} ^[1] | 185 | mA |
| Electrostatic Discharge Threshold (HBM) | - | 3000 | V |
| Thermal Resistance (Junction / Ambient) | $R_{\text{th JA}}$ ^[2] | 480 | $^\circ\text{C}/\text{W}$ |
| Thermal Resistance (Junction / Solder point) | $R_{\text{th JS}}$ ^[2] | 310 | $^\circ\text{C}/\text{W}$ |

Notes:

- 1/10 Duty Cycle, 0.1ms Pulse Width.
- $R_{\text{th JA}}$, $R_{\text{th JS}}$ Results from mounting on PC board FR4 (pad size $\geq 16\text{mm}^2$ per pad).
- Relative humidity levels maintained between 40% and 60% in production area are recommended to avoid the build-up of static electricity – Ref JEDEC/JESD625-A and JEDEC/J-STD-033.

TECHNICAL DATA

RELATIVE INTENSITY vs. WAVELENGTH

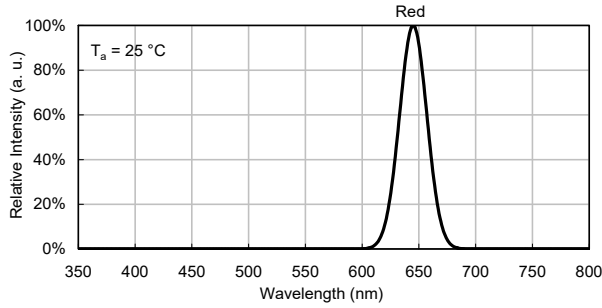

SPATIAL DISTRIBUTION

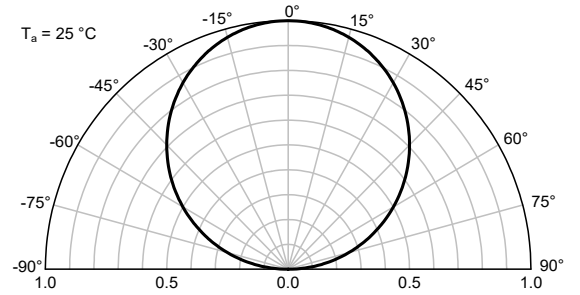

HYPER RED

Forward Current vs. Forward Voltage

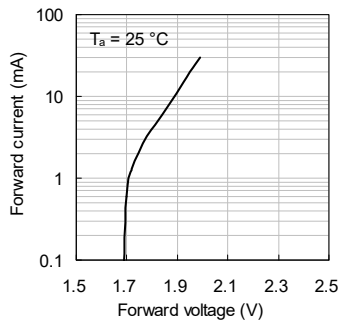

Luminous Intensity vs. Forward Current

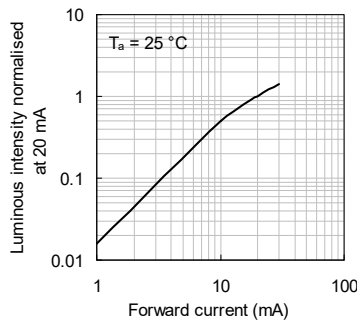

Forward Current Derating Curve

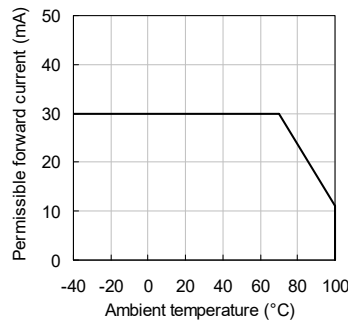

Luminous Intensity vs. Ambient Temperature

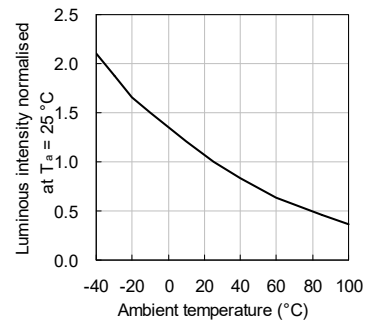

REFLOW SOLDERING PROFILE for LEAD-FREE SMD PROCESS

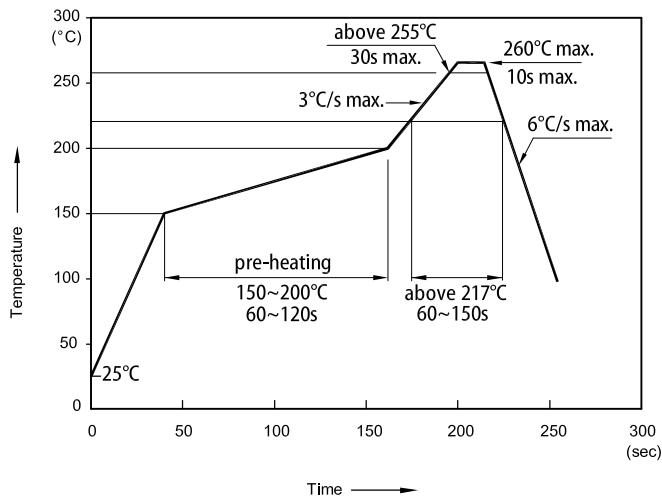

TAPE SPECIFICATIONS (units : mm)

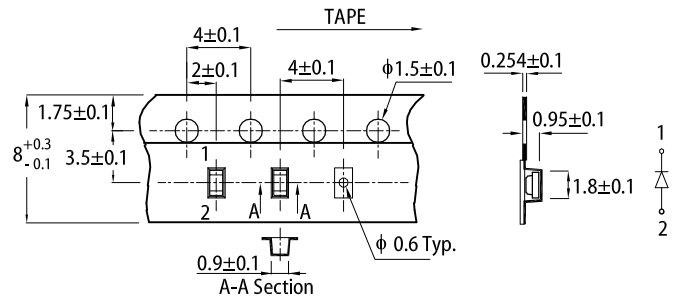

REEL DIMENSION (units : mm)

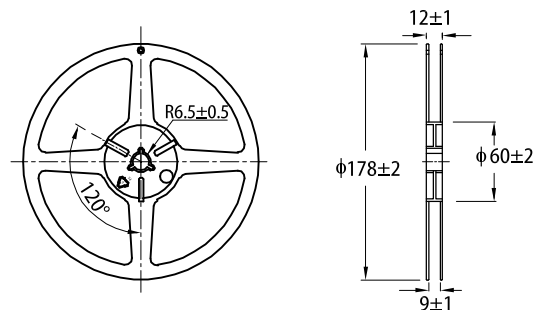

- Notes:
1. Don't cause stress to the LEDs while it is exposed to high temperature.
 2. The maximum number of reflow soldering passes is 2 times.
 3. Reflow soldering is recommended. Other soldering methods are not recommended as they might cause damage to the product.

PACKING & LABEL SPECIFICATIONS

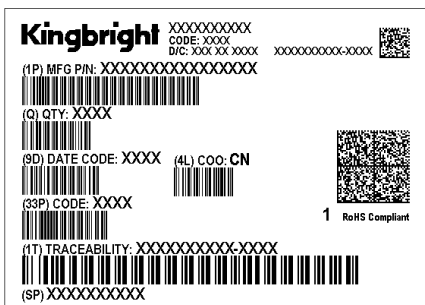
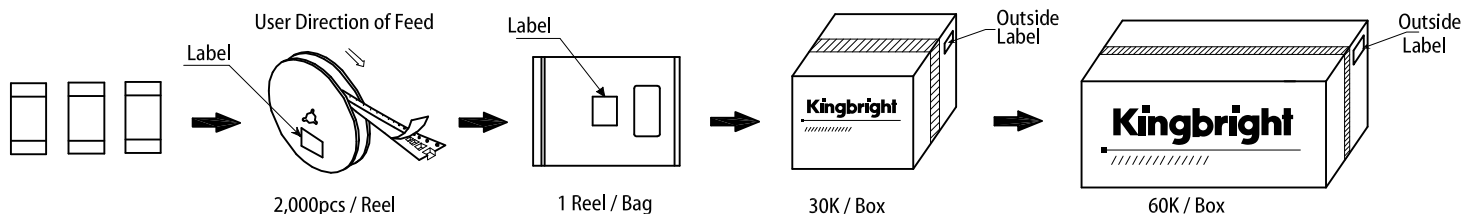

RELIABILITY TEST ITEMS AND CONDITIONS

The reliability of products shall be satisfied with items listed below

LOT TOLERANCE PERCENT DEFECTIVE (LTPD): 10%

| No. | Test Item | Standards | Test Condition | Test Times / Cycles | Number of Damaged |
|-----|--------------------------------------|-----------------------|--|-----------------------|-------------------|
| 1 | Continuous operating test | - | $T_a = 25^{\circ}\text{C}$, $I_F =$ maximum rated current * | 1,000 h | 0 / 22 |
| 2 | High Temp. operating test | EIAJ ED-4701/100(101) | $T_a = 100^{\circ}\text{C}$, $I_F =$ maximum rated current * | 1,000 h | 0 / 22 |
| 3 | Low Temp. operating test | - | $T_a = -40^{\circ}\text{C}$, $I_F =$ maximum rated current * | 1,000 h | 0 / 22 |
| 4 | High temp. storage test | EIAJ ED-4701/100(201) | $T_a =$ maximum rated storage temperature | 1,000 h | 0 / 22 |
| 5 | Low temp. storage test | EIAJ ED-4701/100(202) | $T_a = -40^{\circ}\text{C}$ | 1,000 h | 0 / 22 |
| 6 | High temp. & humidity storage test | EIAJ ED-4701/100(103) | $T_a = 60^{\circ}\text{C}$, RH = 90% | 1,000 h | 0 / 22 |
| 7 | High temp. & humidity operating test | EIAJ ED-4701/100(102) | $T_a = 60^{\circ}\text{C}$, RH = 90% $I_F =$ maximum rated current * | 1,000 h | 0 / 22 |
| 8 | Soldering reliability test | EIAJ ED-4701/100(301) | Moisture soak: 30°C , 70% RH, 72h Preheat: $150\sim 180^{\circ}\text{C}$ (120s max.) Soldering temp: 260°C (10s) | 2 times | 0 / 18 |
| 9 | Thermal shock operating test | - | $T_a = -40^{\circ}\text{C}$ (15min) ~ 100°C (15min) $I_F =$ derated current at 100°C | 1,000 cycles | 0 / 22 |
| 10 | Thermal shock test | - | $T_a = -40^{\circ}\text{C}$ (15min) ~ maximum rated Storage temperature(15min) | 1,000 cycles | 0 / 22 |
| 11 | Electric Static Discharge (ESD) | EIAJ ED-4701/100(304) | $C = 100\text{pF}$, $R_2 = 1.5\text{K}\Omega$ $V = 3000\text{V}$ | Once each Polarity | 0 / 22 |
| 12 | Vibration test | - | $a = 196\text{m/s}^2$, $f = 100\sim 2\text{KHz}$, $t = 48\text{min}$ for all xyz axes | 4 times | 0 / 22 |

*: Refer to forward current vs. derating curve diagram

CRITERIA FOR JUDGING DAMAGE

| Items | Symbols | Conditions | Failure Criteria |
|-------------------------|---------|--|--|
| luminous Intensity | I_V | $I_F = 20\text{mA}$ | Testing Min. Value < Spec. Min. Value x 0.5 |
| Forward Voltage | V_F | $I_F = 20\text{mA}$ | Testing Max. Value \geq Spec. Max. Value x 1.2 |
| Reverse Current | I_R | $V_R = \text{Maximum Rated Reverse Voltage}$ | Testing Max. Value \geq Spec. Max. Value x 2.5 |
| High temp. storage test | - | - | Occurrence of notable decoloration, deformation and cracking |

PRECAUTIONARY NOTES

1. The information included in this document reflects representative usage scenarios and is intended for technical reference only.
2. The part number, type, and specifications mentioned in this document are subject to future change and improvement without notice. Before production usage customer should refer to the latest datasheet for the updated specifications.
3. When using the products referenced in this document, please make sure the product is being operated within the environmental and electrical limits specified in the datasheet. If customer usage exceeds the specified limits, Kingbright will not be responsible for any subsequent issues.
4. The information in this document applies to typical usage in consumer electronics applications. If customer's application has special reliability requirements or have life-threatening liabilities, such as automotive or medical usage, please consult with Kingbright representative for further assistance.
5. The contents and information of this document may not be reproduced or re-transmitted without permission by Kingbright.
6. All design applications should refer to Kingbright application notes available at <https://www.KingbrightUSA.com/ApplicationNotes>